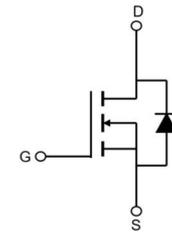


## Feature

- 60V,80A  
 $R_{DS(ON)} < 8m\Omega @ V_{GS}=10V$
- Advanced Trench Technology
- Lead free product is acquired
- Excellent  $R_{DS(ON)}$  and Low Gate Charge



Schematic Diagram



Marking and pin assignment

## Application

- PWM applications
- Load Switch
- Power management

## Package Marking and Ordering Information

Device Marking	Device	Device Package	Reel Size	Tape width	Quantity (PCS)
90N06HK	AP90N06HK	TO-252	13 inch	-	2500

## ABSOLUTE MAXIMUM RATINGS ( $T_a=25^\circ\text{C}$ unless otherwise noted)

Parameter	Symbol	Value	Unit
Drain-Source Voltage	$V_{DS}$	60	V
Gate-Source Voltage	$V_{GS}$	$\pm 20$	V
Continuous Drain Current ( $T_a=25^\circ\text{C}$ )	$I_D$	80	A
Continuous Drain Current ( $T_a=100^\circ\text{C}$ )	$I_D$	52	A
Pulsed Drain Current <sup>(1)</sup>	$I_{DM}$	320	A
Singel Pulsed Avalanche Energy <sup>(2)</sup>	$E_{AS}$	130	mJ
Power Dissipation	$P_D$	108	W
Thermal Resistance from Junction to Case	$R_{\theta JC}$	1.4	$^\circ\text{C}/\text{W}$
Junction Temperature	$T_J$	150	$^\circ\text{C}$
Storage Temperature	$T_{STG}$	-55~ +150	$^\circ\text{C}$

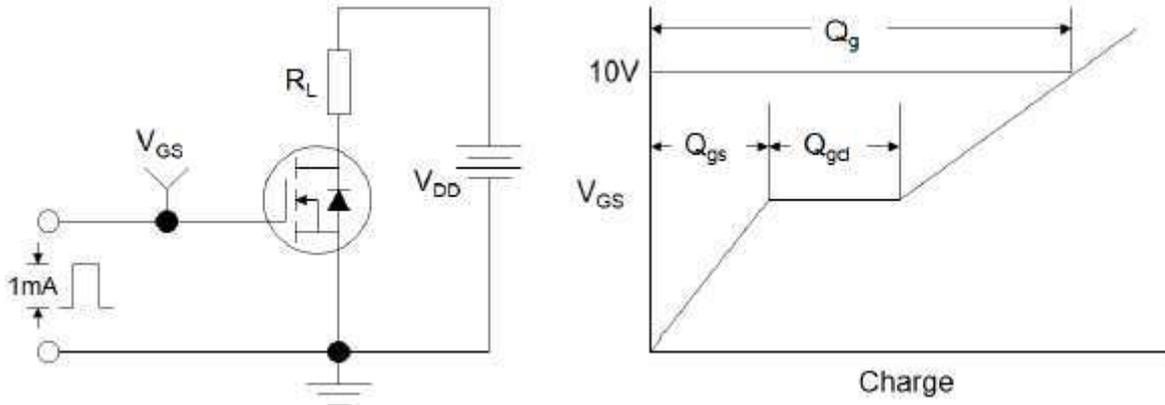
MOSFET ELECTRICAL CHARACTERISTICS( $T_a=25^{\circ}\text{C}$  unless otherwise noted)

Parameter	Symbol	Test Condition	Min	Type	Max	Unit
<b>Static Characteristics</b>						
Drain-source breakdown voltage	$V_{(BR)DSS}$	$V_{GS} = 0V, I_D = -250\mu A$	60	-	-	V
Zero gate voltage drain current	$I_{DSS}$	$V_{DS} = 100V, V_{GS} = 0V$	-	-	1	$\mu A$
Gate-body leakage current	$I_{GSS}$	$V_{GS} = \pm 20V, V_{DS} = 0V$	-	-	$\pm 100$	nA
Gate threshold voltage <sup>(3)</sup>	$V_{GS(th)}$	$V_{DS} = V_{GS}, I_D = 250\mu A$	2	3.2	4	V
Drain-source on-resistance <sup>(3)</sup>	$R_{DS(on)}$	$V_{GS} = 10V, I_D = 30A$	-	5.3	8	m $\Omega$
<b>Dynamic characteristics</b>						
Input Capacitance	$C_{iss}$	$V_{DS} = 30V, V_{GS} = 0V, f = 1MHz$	-	4136	-	pF
Output Capacitance	$C_{oss}$		-	286	-	
Reverse Transfer Capacitance	$C_{rss}$		-	257	-	
<b>Switching characteristics</b>						
Turn-on delay time	$t_{d(on)}$	$V_{DD} = 30V, I_D = 30A, R_L = 1\Omega$ $V_{GS} = 10V, R_G = 3\Omega$	-	9	-	ns
Turn-on rise time	$t_r$		-	7	-	
Turn-off delay time	$t_{d(off)}$		-	40	-	
Turn-off fall time	$t_f$		-	15	-	
Total Gate Charge	$Q_g$	$V_{DS} = 30V, I_D = 30A,$ $V_{GS} = 10V$	-	90	-	nC
Gate-Source Charge	$Q_{gs}$		-	9	-	
Gate-Drain Charge	$Q_{gd}$		-	18	-	
<b>Source-Drain Diode characteristics</b>						
Diode Forward voltage <sup>(3)</sup>	$V_{DS}$	$V_{GS} = 0V, I_S = 30A$	-	-	1.2	V
Diode Forward current <sup>(4)</sup>	$I_S$		-	-	80	A
Body Diode Reverse Recovery Time	$t_{rr}$	$T_J = 25^{\circ}, I_F = 30A, di/dt = 100A/\mu s$		33		ns
Body Diode Reverse Recovery Charge	$Q_{rr}$	$T_J = 25^{\circ}, I_F = 30A, di/dt = 100A/\mu s$		46		nc

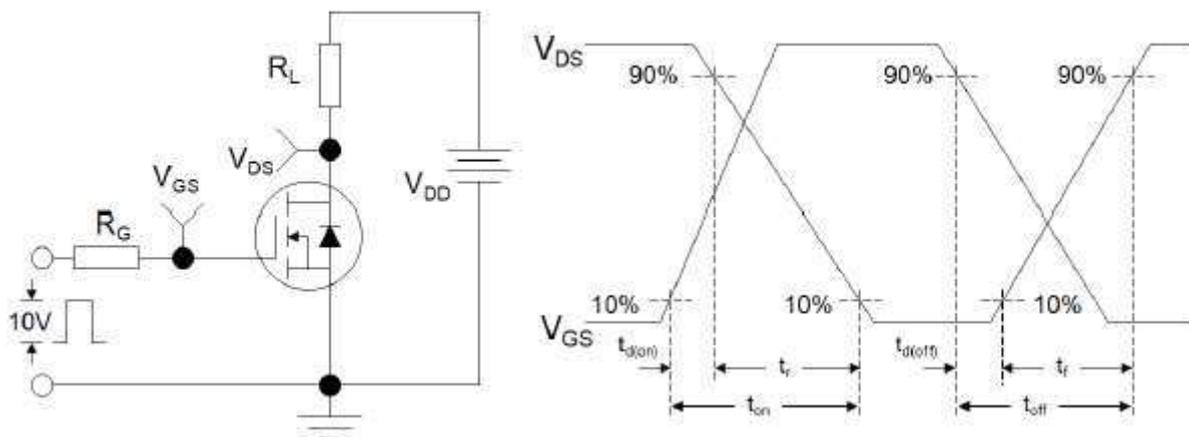
**Notes:**

1. Repetitive Rating: pulse width limited by maximum junction temperature
2. EAS Condition:  $T_J = 25^{\circ}\text{C}, V_{DD} = 20V, R_G = 25\Omega, L = 0.5\text{mH}, I_{AS} = 22.8\text{A}$
3. Pulse Test: pulse width  $\leq 300\mu s$ , duty cycle  $\leq 2\%$
4. Surface Mounted on FR4 Board,  $t \leq 10\text{ sec}$

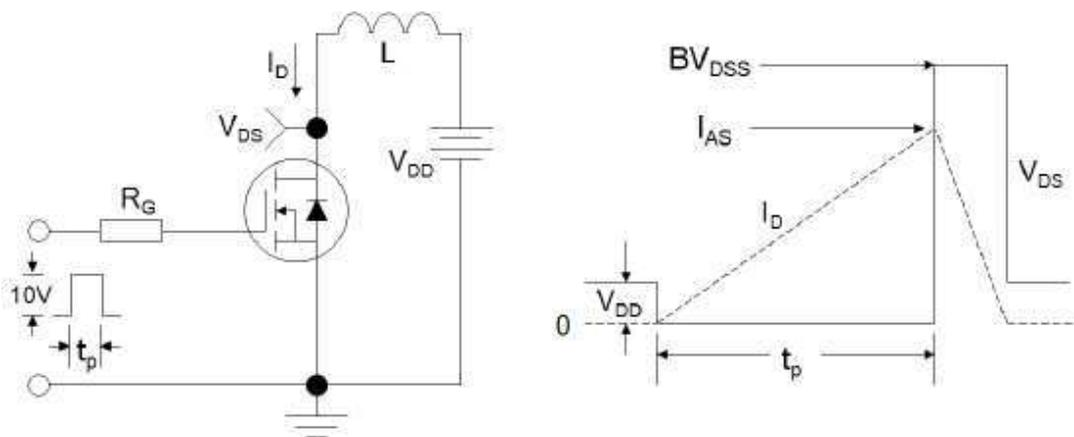
**Test Circuit**



**Figure 1: Gate Charge Test Circuit & Waveform**

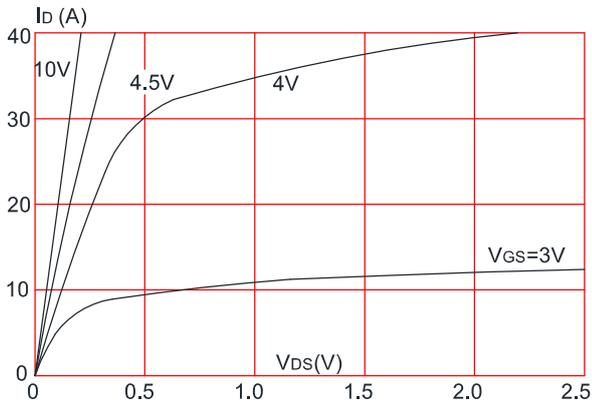


**Figure 2: Resistive Switching Test Circuit & Waveforms**

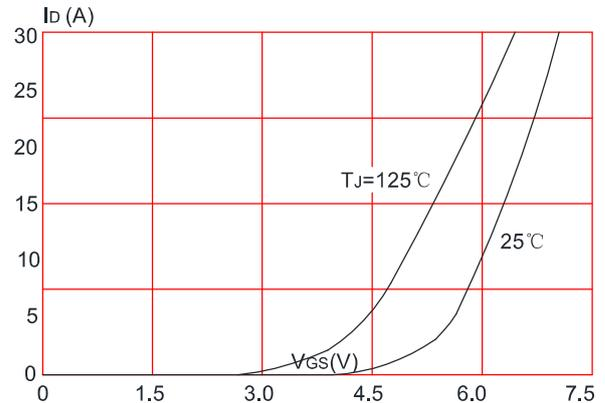


**Figure 3: Unclamped Inductive Switching Test Circuit & Waveforms**

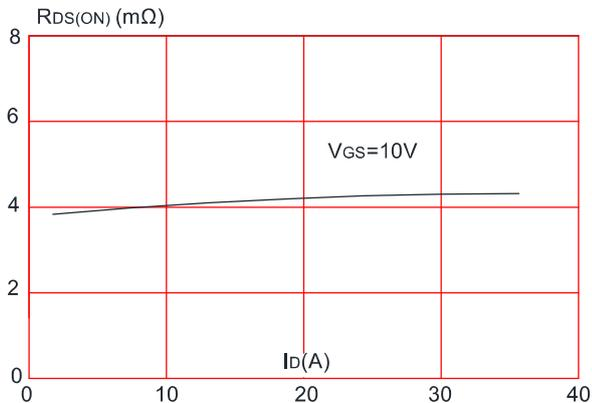
**Figure 1: Output Characteristics**



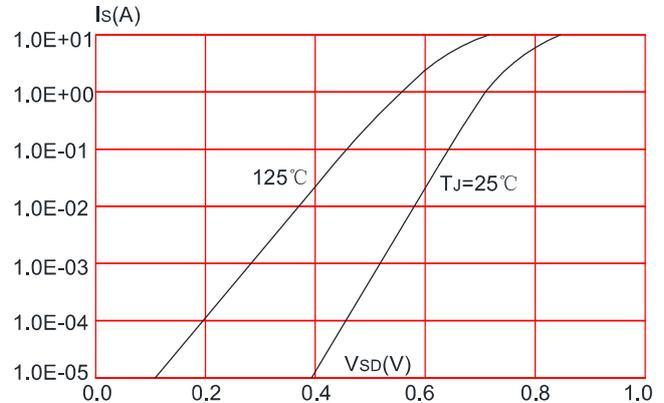
**Figure 2: Typical Transfer Characteristics**



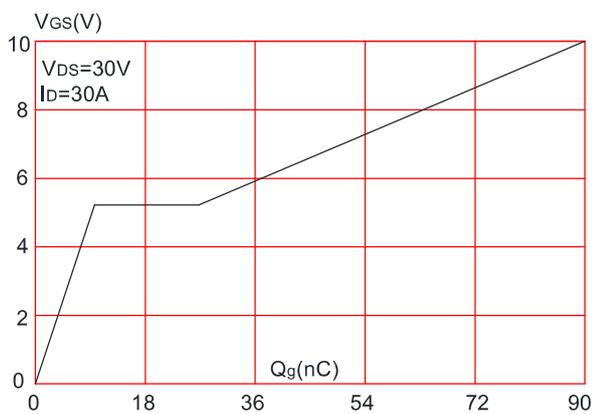
**Figure 3: On-resistance vs. Drain Current**



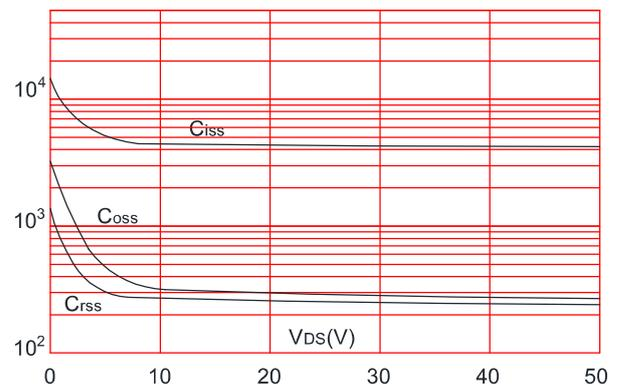
**Figure 4: Body Diode Characteristics**



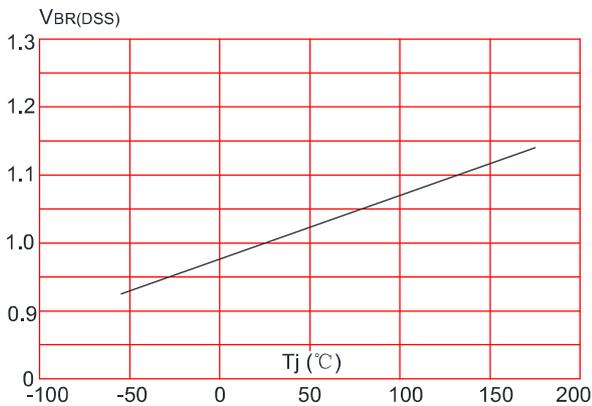
**Figure 5: Gate Charge Characteristics**



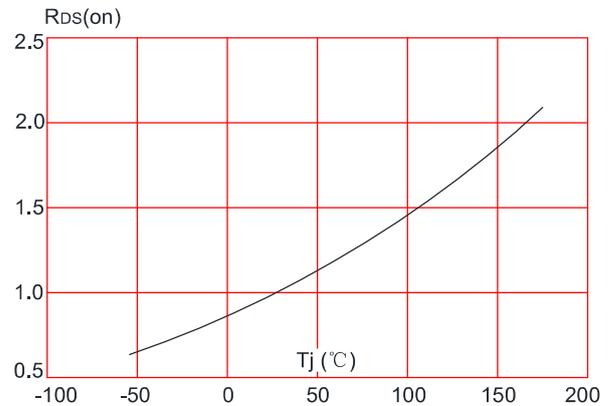
**Figure 6: Capacitance Characteristics**



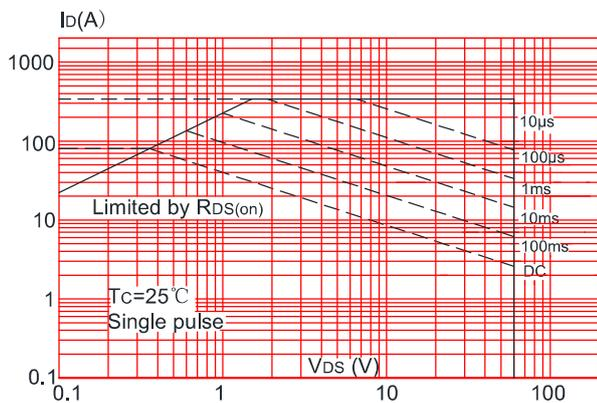
**Figure 7:** Normalized Breakdown Voltage vs. Junction Temperature



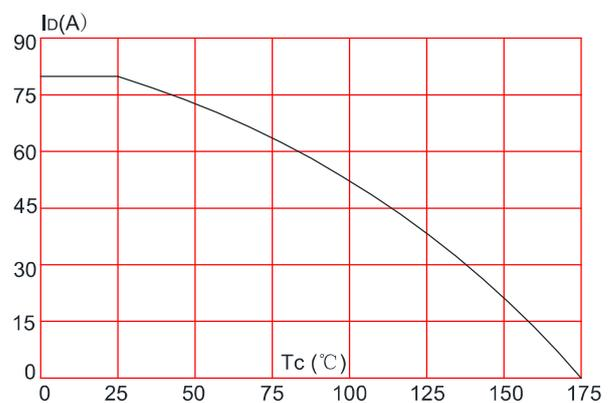
**Figure 8:** Normalized on Resistance vs. Junction Temperature



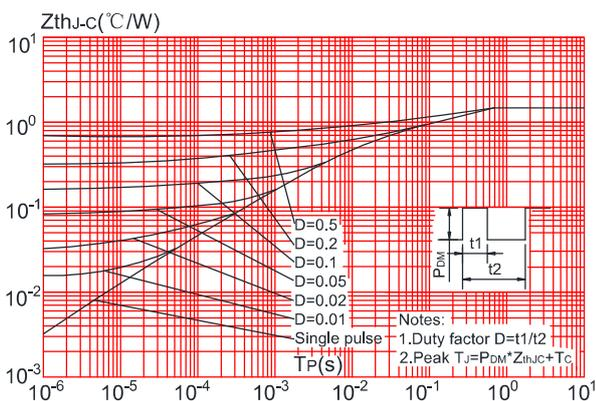
**Figure 9:** Maximum Safe Operating Area



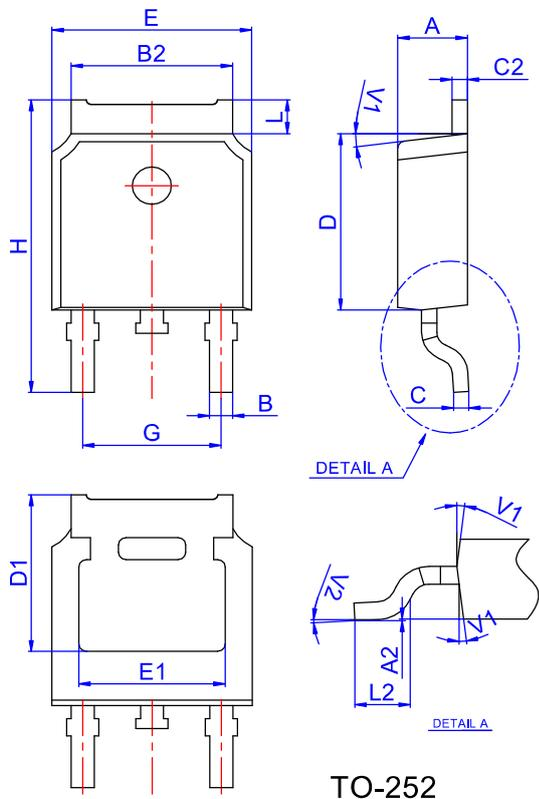
**Figure 10:** Maximum Continuous Drain Current vs. Case Temperature



**Figure.11:** Maximum Effective Transient Thermal Impedance, Junction-to-Case

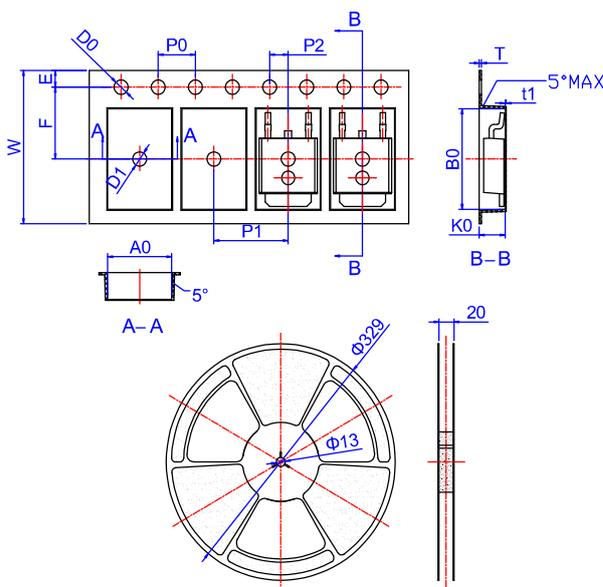


**TO-252 Package Information**



Ref.	Dimensions					
	Millimeters			Inches		
	Min.	Typ.	Max.	Min.	Typ.	Max.
A	2.10		2.50	0.083		0.098
A2	0		0.10	0		0.004
B	0.66		0.86	0.026		0.034
B2	5.18		5.48	0.202		0.216
C	0.40		0.60	0.016		0.024
C2	0.44		0.58	0.017		0.023
D	5.90		6.30	0.232		0.248
D1	5.30REF			0.209REF		
E	6.40		6.80	0.252		0.268
E1	4.63			0.182		
G	4.47		4.67	0.176		0.184
H	9.50		10.70	0.374		0.421
L	1.09		1.21	0.043		0.048
L2	1.35		1.65	0.053		0.065
V1		7°			7°	
V2	0°		6°	0°		6°

**Reel Specification-TO-252**



Ref.	Dimensions					
	Millimeters			Inches		
	Min.	Typ.	Max.	Min.	Typ.	Max.
W	15.90	16.00	16.10	0.626	0.630	0.634
E	1.65	1.75	1.85	0.065	0.069	0.073
F	7.40	7.50	7.60	0.291	0.295	0.299
D0	1.40	1.50	1.60	0.055	0.059	0.063
D1	1.40	1.50	1.60	0.055	0.059	0.063
P0	3.90	4.00	4.10	0.154	0.157	0.161
P1	7.90	8.00	8.10	0.311	0.315	0.319
P2	1.90	2.00	2.10	0.075	0.079	0.083
A0	6.85	6.90	7.00	0.270	0.271	0.276
B0	10.45	10.50	10.60	0.411	0.413	0.417
K0	2.68	2.78	2.88	0.105	0.109	0.113
T	0.24		0.27	0.009		0.011
t1	0.10			0.004		
10P0	39.80	40.00	40.20	1.567	1.575	1.583