

## Feature

- 500V,3A  
 $R_{DS(ON)} < 3.0 \Omega @ V_{GS}=10V$  TYP:2.6  $\Omega$
- Fast Switching
- Lead free product is acquired
- Excellent  $R_{DS(ON)}$  and Low Gate Charge

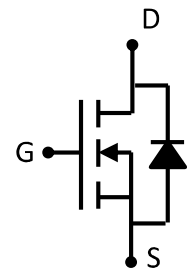

Schematic diagram

## Application

- PWM applications
- Load Switch
- Power management

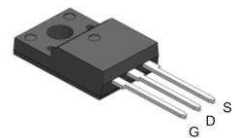

TO-220F

## Package Marking and Ordering Information

Device Marking	Device	Device Package	Reel Size	Tape width	Quantity (PCS)
3N50F	AP3N50F	TO-220F	-	-	1000

## ABSOLUTE MAXIMUM RATINGS ( $T_a=25^\circ\text{C}$ unless otherwise noted)

Parameter	Symbol	Value	Unit
Drain-Source Voltage	$V_{DS}$	500	V
Gate-Source Voltage	$V_{GS}$	$\pm 30$	V
Continuous Drain Current ( $T_a=25^\circ\text{C}$ )	$I_D$	3	A
Continuous Drain Current ( $T_a=100^\circ\text{C}$ )	$I_D$	1.8	A
Pulsed Drain Current <sup>(1)</sup>	$I_{DM}$	12	A
Single Pulsed Avalanche Energy <sup>(2)</sup>	$E_{AS}$	45	mJ
Power Dissipation	$P_D$	25	W
Thermal Resistance from Junction to Case	$R_{\theta JC}$	4.9	$^\circ\text{C}/\text{W}$
Junction Temperature	$T_J$	150	$^\circ\text{C}$
Storage Temperature	$T_{STG}$	-55~ +150	$^\circ\text{C}$

**MOSFET ELECTRICAL CHARACTERISTICS(T<sub>a</sub>=25°C unless otherwise noted)**

Parameter	Symbol	Test Condition	Min	Type	Max	Unit
<b>Static Characteristics</b>						
Drain-source breakdown voltage	V <sub>(BR)DSS</sub>	V <sub>GS</sub> = 0V, I <sub>D</sub> =250μA	500	-	-	V
Zero gate voltage drain current	I <sub>DSS</sub>	V <sub>DS</sub> =500V, V <sub>GS</sub> = 0V	-	-	1	μA
Gate-body leakage current	I <sub>GSS</sub>	V <sub>GS</sub> =±30V, V <sub>DS</sub> = 0V	-	-	±100	nA
Gate threshold voltage <sup>(3)</sup>	V <sub>GS(th)</sub>	V <sub>DS</sub> =V <sub>GS</sub> , I <sub>D</sub> =250μA	2	3.1	4	V
Drain-source on-resistance <sup>(3)</sup>	R <sub>DS(on)</sub>	V <sub>GS</sub> =10V, I <sub>D</sub> =1.5A	-	2.6	3.0	Ω
Forward tranconductance <sup>(3)</sup>	g <sub>FS</sub>	V <sub>DS</sub> =10V, I <sub>D</sub> =1.5A	0.5	-	-	S
<b>Dynamic characteristics</b>						
Input Capacitance	C <sub>iss</sub>	V <sub>DS</sub> =25V, V <sub>GS</sub> =0V, f =1MHz	-	278	-	pF
Output Capacitance	C <sub>oss</sub>		-	20	-	
Reverse Transfer Capacitance	C <sub>rss</sub>		-	5	-	
<b>Switching characteristics</b>						
Turn-off delay time	t <sub>d(off)</sub>	V <sub>DD</sub> =300V, I <sub>D</sub> =3A, V <sub>GS</sub> =10V, R <sub>G</sub> =25Ω	-	13	-	ns
Total Gate Charge	Q <sub>g</sub>	V <sub>DS</sub> =480V, I <sub>D</sub> =1A, V <sub>GS</sub> =10V	-	4.8	-	nC
Gate-Source Charge	Q <sub>gs</sub>		-	0.7	-	
Gate-Drain Charge	Q <sub>gd</sub>		-	2.7	-	
<b>Source-Drain Diode characteristics</b>						
Diode Forward voltage <sup>(3)</sup>	V <sub>DS</sub>	V <sub>GS</sub> =0V, I <sub>S</sub> =3A	-	-	1.4	V
Diode Forward current <sup>(4)</sup>	I <sub>S</sub>		-	-	3	A
Body Diode Reverse Recovery Time	t <sub>rr</sub>	T <sub>J</sub> =25° , IF=3A, di/dt=100A/us		190		ns
Body Diode Reverse Recovery Charge	Q <sub>rr</sub>	T <sub>J</sub> =25° , IF=3A, di/dt=100A/us		0.53		uc

**Notes:**

1. Repetitive Rating: pulse width limited by maximum junction temperature
2. EAS Condition: T<sub>J</sub>=25°C, V<sub>DD</sub>=50V, R<sub>G</sub>=2.0 Ω, L=10mH
3. Pulse Test: pulse width≤300μs, duty cycle≤2%
4. Surface Mounted on FR4 Board, t≤10 sec

**Typical Characteristics**

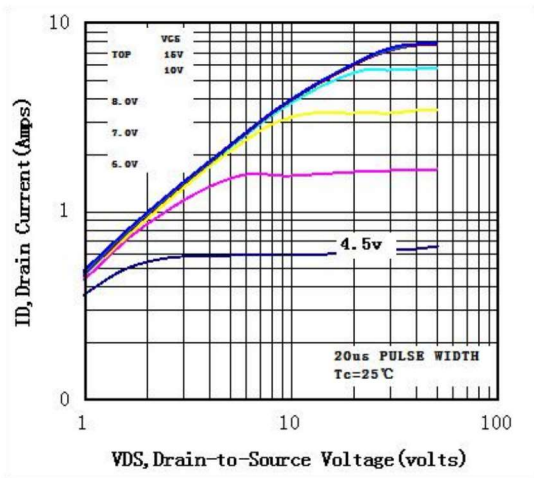

Fig1 Typical Output Characteristics,  $T_c=25^\circ\text{C}$

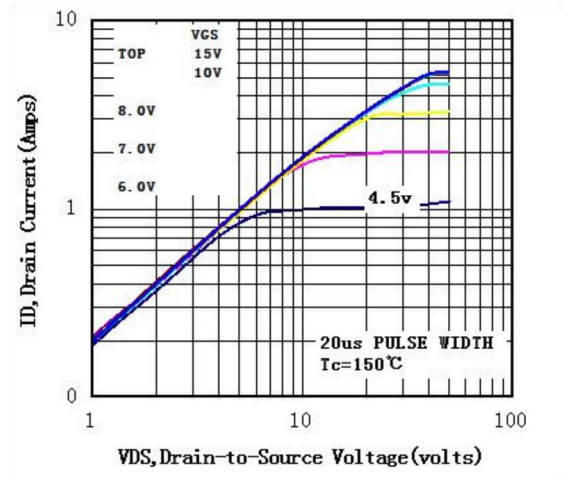

Fig2 Typical Output Characteristics,  $T_c=150^\circ\text{C}$

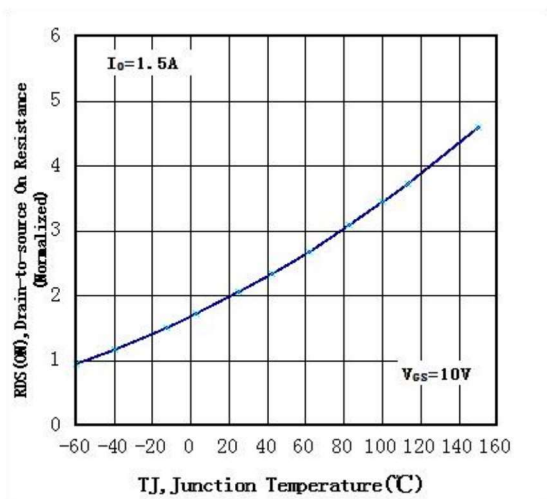

Fig3 Normalized On-Resistance Vs. Temperature

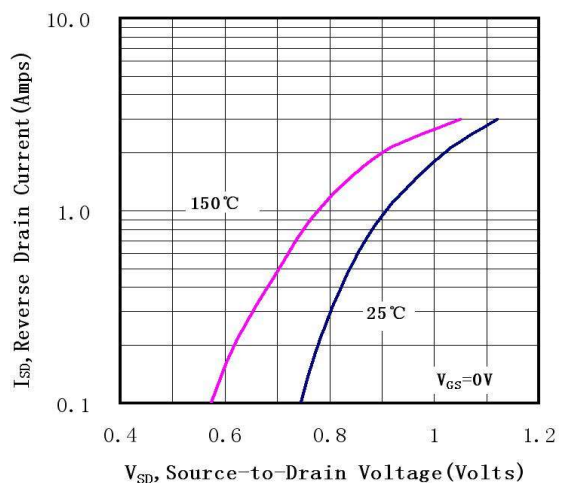

Fig4 Typical Source-Drain Diode Forward Voltage

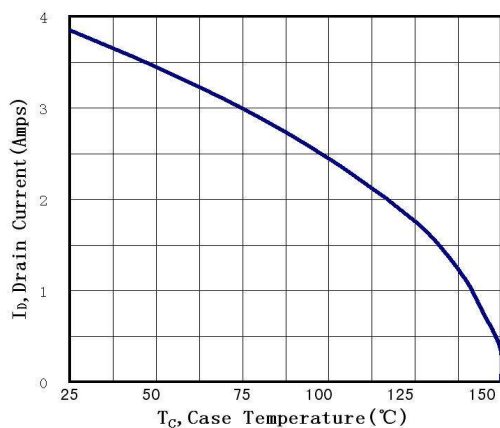

Fig5 Maximum Drain Current Vs. Case Temperature

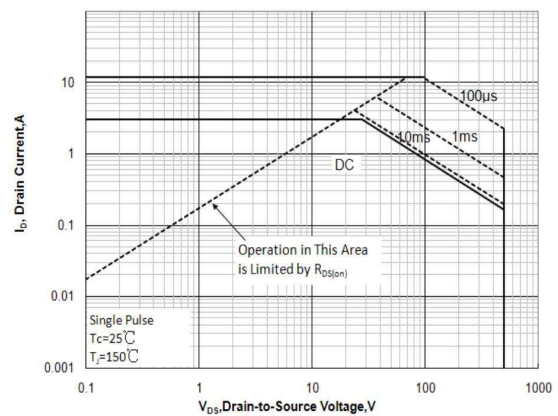
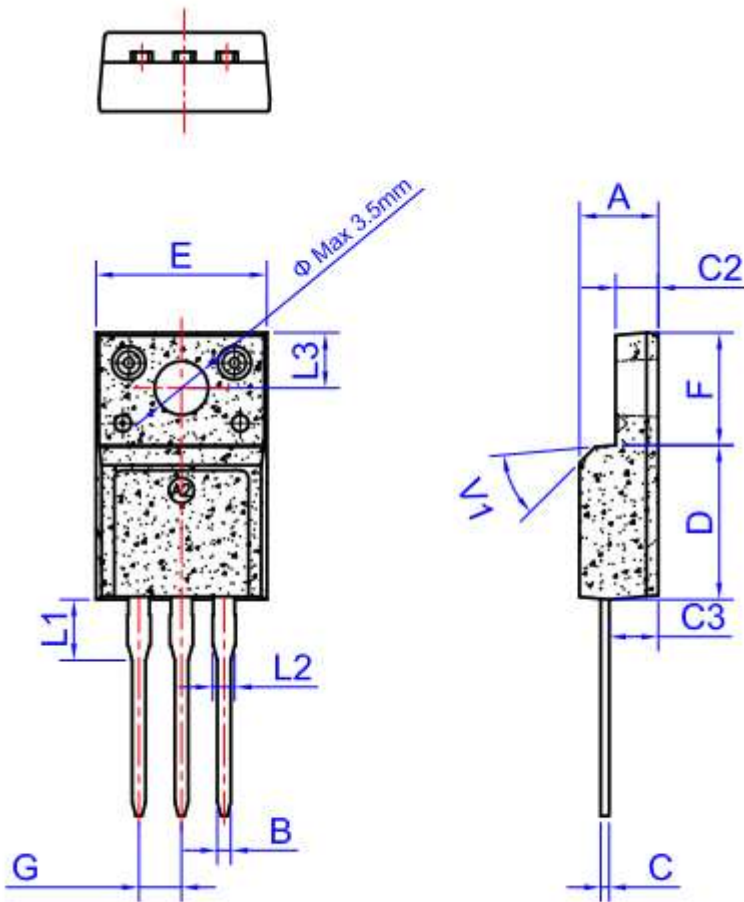

Fig6 Maximum Safe Operating Area

**AP3N50F**  
N-Channel Power Mosfet

**Package Outlines**



Ref.	Dimensions					
	Millimeters			Inches		
	Min.	Typ.	Max.	Min.	Typ.	Max.
A	4.50		4.90	0.177		0.193
B	0.74	0.80	0.83	0.029	0.031	0.033
C	0.47		0.65	0.019		0.026
C2	2.45		2.75	0.096		0.108
C3	2.60		3.00	0.102		0.118
D	8.80		9.30	0.346		0.366
E	9.80		10.4	0.386		0.410
F	6.40		6.80	0.252		0.268
G		2.54			0.1	
H	28.0		29.8	1.102		1.173
L1		3.63			0.143	
L2	1.14		1.70	0.045		0.067
L3		3.30			0.130	
V1		45°			45°	