

Feature

- 100V,60A
 $R_{DS(on)} < 9.5m\Omega @ V_{GS}=10V$ (TYP:8.2m Ω)
 $R_{DS(on)} < 13m\Omega @ V_{GS}=4.5V$ (TYP:11.3m Ω)
- Split Gate Trench Technology
- Lead free product is acquired
- Excellent $R_{DS(on)}$ and Low Gate Charge

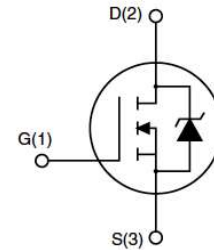

Application

- PWM applications
- Load Switch
- Power management

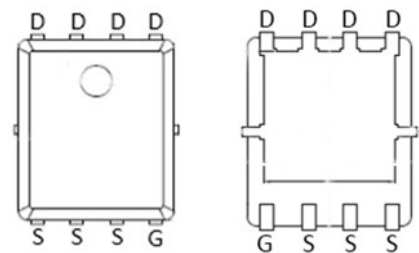

PDFN5X6-8L

Package Marking and Ordering Information

Device Marking	Device	Device Package	Reel Size	Tape width	Quantity (PCS)
G095N01G	APG095N01G	PDFN5*6-8L	13 inch	-	5000

ABSOLUTE MAXIMUM RATINGS (T_a=25°C unless otherwise noted)

Parameter	Symbol	Value	Unit
Drain-Source Voltage	V _{DS}	100	V
Gate-Source Voltage	V _{GS}	±20	V
Continuous Drain Current (T _a =25°C)	I _D	60	A
Continuous Drain Current (T _a =100°C)	I _D	38	A
Pulsed Drain Current ⁽¹⁾	I _{DM}	240	A
Singel Pulsed Avalanche Energy ⁽²⁾	E _{AS}	90	mJ
Power Dissipation	P _D	63	W
Thermal Resistance from Junction to Case	R _{θJC}	2.0	°C/W
Junction Temperature	T _J	150	°C
Storage Temperature	T _{STG}	-55~ +150	°C

MOSFET ELECTRICAL CHARACTERISTICS(T_a=25°C unless otherwise noted)

Parameter	Symbol	Test Condition	Min	Type	Max	Unit
Static Characteristics						
Drain-source breakdown voltage	V _{(BR)DSS}	V _{GS} = 0V, I _D =250μA	100	-	-	V
Zero gate voltage drain current	I _{DSS}	V _{DS} =80V, V _{GS} = 0V	-	-	1	μA
Gate-body leakage current	I _{GSS}	V _{GS} =±20V, V _{DS} = 0V	-	-	±100	nA
Gate threshold voltage ⁽³⁾	V _{GS(th)}	V _{DS} =V _{GS} , I _D =250μA	1.2	2.0	2.5	V
Drain-source on-resistance ⁽³⁾	R _{DS(on)}	V _{GS} =10V, I _D =20A	-	8.2	9.5	mΩ
		V _{GS} =4.5V, I _D =10A	-	11.3	13	
Forward Threshold Voltage	g _{fs}	V _{DS} =5V, I _D =20A	-	13.5	-	S
Gate Resistance	R _g	V _{DS} =V _{GS} =0V, f =1MHz	-	1.94	-	Ω
Dynamic characteristics						
Input Capacitance	C _{iSS}	V _{DS} =50V, V _{GS} =0V, f =1MHz	-	2122	-	pF
Output Capacitance	C _{oss}		-	618	-	
Reverse Transfer Capacitance	C _{rSS}		-	25	-	
Switching characteristics						
Turn-on delay time	t _{d(on)}	V _{DD} =50V, I _D =20A, V _{GS} =10V, R _G =3Ω	-	17	-	ns
Turn-on rise time	t _r		-	4	-	
Turn-off delay time	t _{d(off)}		-	32	-	
Turn-off fall time	t _f		-	8	-	
Total Gate Charge	Q _g	V _{DS} =50V, I _D =20A, V _{GS} =10V	-	41.8	-	nC
Gate-Source Charge	Q _{gs}		-	9	-	
Gate-Drain Charge	Q _{gd}		-	10	-	
Reverse Recovery Chrage	Q _{rr}	I _F =20A, di/dt=100A/us		71.5		nC
Reverse Recovery Time	T _{rr}	I _F =20A, di/dt=100A/us		50.5		ns
Source-Drain Diode characteristics						
Diode Forward voltage ⁽³⁾	V _{DS}	V _{GS} =0V, I _S =20A	-	-	1.2	V
Diode Forward current ⁽⁴⁾	I _S		-	-	60	A

Notes:

1. Repetitive Rating: pulse width limited by maximum junction temperature
2. EAS Condition: T_J=25°C, V_{DD}=50V, R_G=25 Ω, L=0.5mH
3. Pulse Test: pulse width≤300μs, duty cycle≤2%
4. Surface Mounted on FR4 Board, t≤10 sec

Typical Performance Characteristics

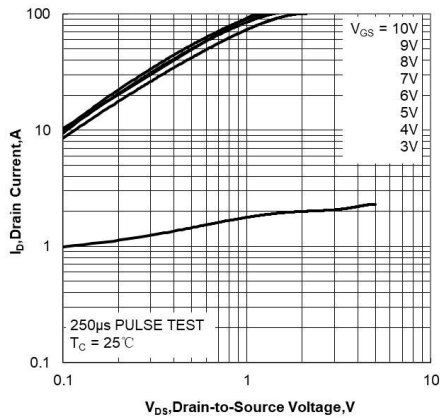

Figure 1. Output Characteristics

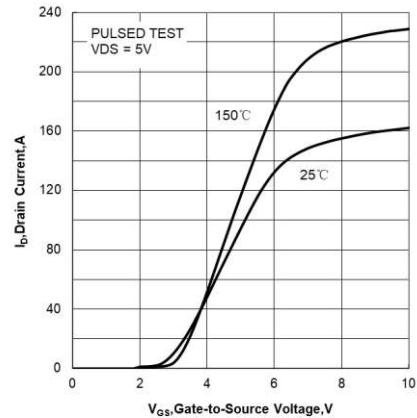

Figure 2. Transfer Characteristics

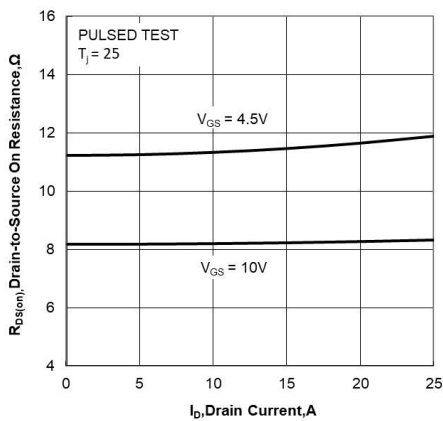

Figure 3. Drain-to-Source On Resistance vs Drain Current

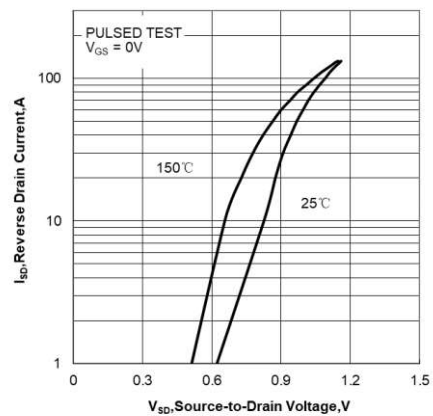

Figure 4. Body Diode Forward Voltage vs Source Current and Temperature

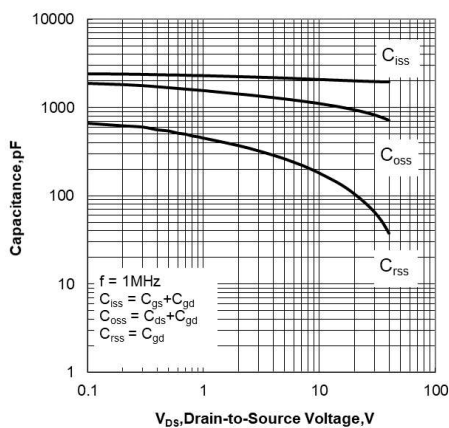

Figure 5. Capacitance Characteristics

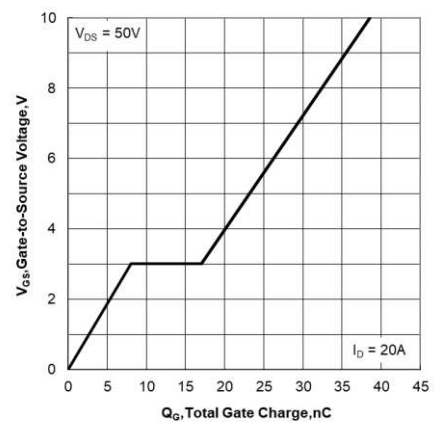

Figure 6. Gate Charge Characteristics

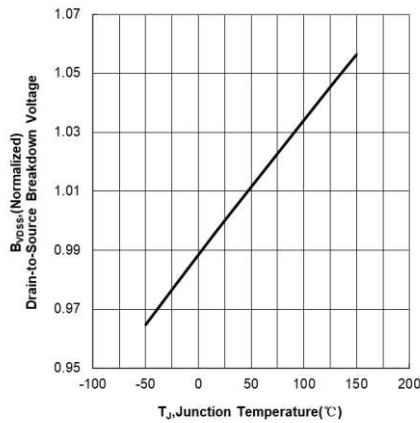

Figure 7. Normalized Breakdown Voltage vs Junction Temperature

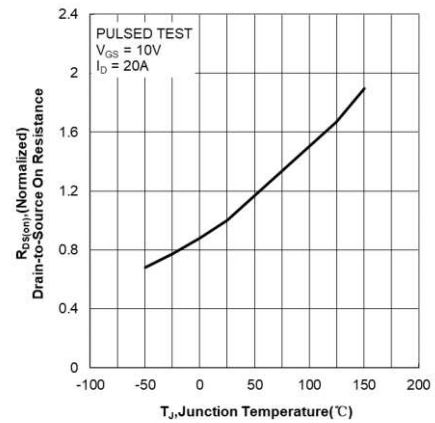

Figure 8. Normalized On Resistance vs Junction Temperature

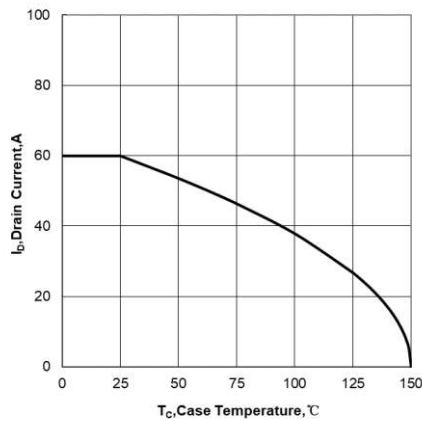

Figure 9. Maximum Continuous Drain Current vs Case Temperature

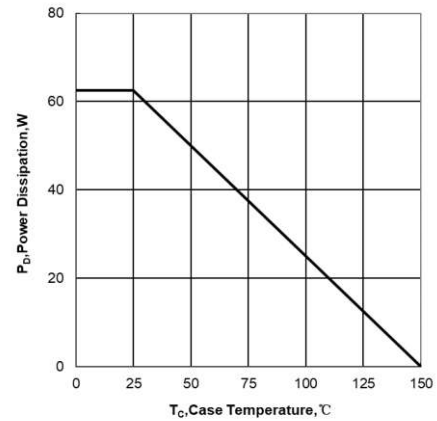

Figure 10. Maximum Power Dissipation vs Case Temperature

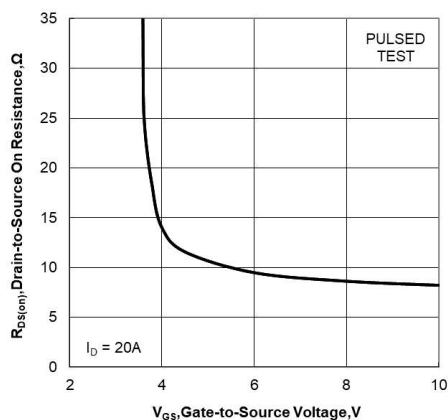

Figure 11. Drain-to-Source On Resistance vs Gate Voltage and Drain Current

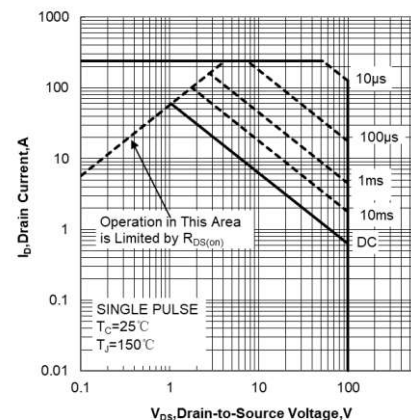

Figure 12. Maximum Safe Operating Area

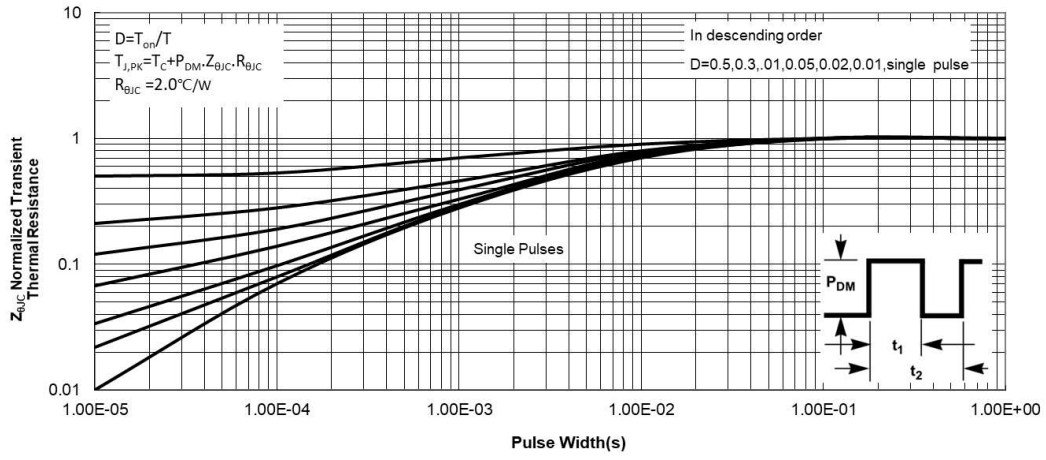
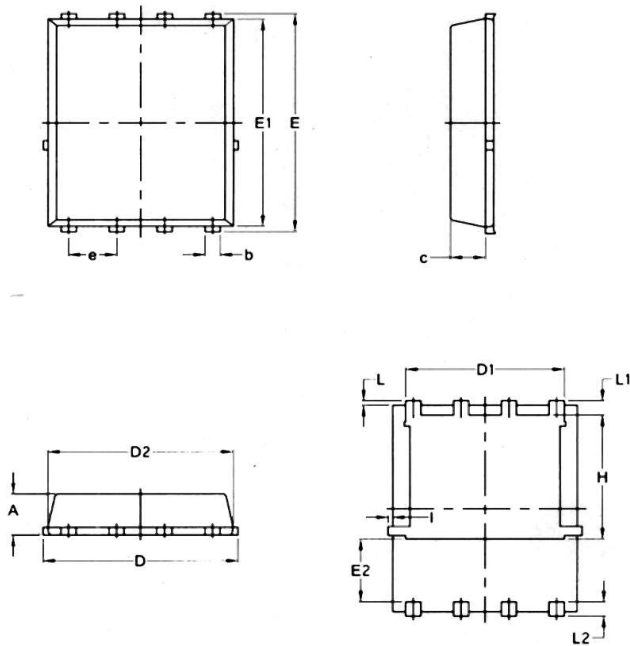

Figure 13. Maximum Effective Transient Thermal Impedance, Junction-to-Case

PDFN5*6-8L Package Information



PDFN5X6-8L

SYMBOL	COMMON			
	MM		INCH	
	MIN.	MAX.	MIN.	MAX.
A	1.03	1.17	0.0406	0.0461
b	0.34	0.48	0.0134	0.0189
c	0.824	0.970	0.0324	0.0382
D	4.80	5.40	0.1890	0.2126
D1	4.11	4.31	0.1618	0.1697
D2	4.80	5.00	0.1890	0.1969
E	5.95	6.15	0.2343	0.2421
E1	5.65	5.85	0.2224	0.2303
E2	1.60	—	0.0630	—
e	1.27 BSC		0.05 BSC	
L	0.05	0.25	0.0020	0.0098
L1	0.38	0.50	0.0150	0.0197
L2	0.38	0.50	0.0150	0.0197
H	3.30	3.50	0.1299	0.1378
I	—	0.18	—	0.0070