

AP3908GD

N and P-Channel Enhancement Mosfet

Feature

- **N-Channel**
 $V_{DD}=30V, I_D=36A$
 $R_{DS(on)} < 13m\Omega @ V_{GS}=10V$
 $R_{DS(on)} < 19m\Omega @ V_{GS}=4.5V$
- **P-Channel**
 $V_{DD}=-30V, I_D=-25A$
 $R_{DS(on)} < 23m\Omega @ V_{GS}=-10V$
 $R_{DS(on)} < 34m\Omega @ V_{GS}=-4.5V$
- Lead free product is acquired
- High power and current handing capability
- Surface mount package

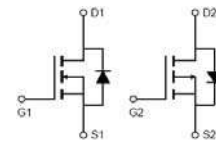

Schematic diagram

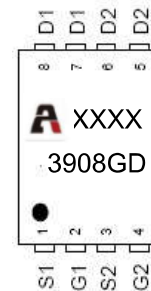

Marking and pin assignment

Application

- PWM applications
- Load Switch
- Power management

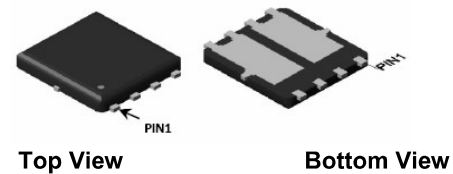

Package Marking and Ordering Information

Device Marking	Device	Device Package	Reel Size	Tape width	Quantity (PCS)
3908GD	AP3908GD	PDFN5X6	13 inch	-	5000

ABSOLUTE MAXIMUM RATINGS ($T_a=25^\circ C$ unless otherwise noted)

Parameter	Symbol	N-Channel	P-Channel	Unit
Drain-Source Voltage	V_{DS}	30	-30	V
Gate-Source Voltage	V_{GS}	± 20	± 20	V
Continuous Drain Current ($T_a = 25^\circ C$)	I_D	36	-25	A
Continuous Drain Current ($T_a = 100^\circ C$)	I_D	22.8	-18.2	A
Pulsed Drain Current ⁽¹⁾	I_{DM}	90	-70	A
Power Dissipation	P_D	32		W
Thermal Resistance from Junction to Case	$R_{\theta JC}$	3.85		$^\circ C/W$
Junction Temperature	T_J	150		$^\circ C$
Storage Temperature	T_{STG}	-55~ +150		$^\circ C$

AP3908GD

N and P-Channel Enhancement Mosfet



DATA SHEET

N-CH ELECTRICAL CHARACTERISTICS(T_a=25°C unless otherwise noted)

Parameter	Symbol	Test Condition	Min	Type	Max	Unit
Static Characteristics						
Drain-source breakdown voltage	V _{(BR)DSS}	V _{GS} = 0V, I _D =250μA	30			V
Zero gate voltage drain current	I _{DSS}	V _{DS} =30V, V _{GS} = 0V			1	μA
Gate-body leakage current	I _{GSS}	V _{GS} =±20V, V _{DS} = 0V			±100	nA
Gate threshold voltage ⁽²⁾	V _{GS(th)}	V _{DS} =V _{GS} , I _D =250μA	1	1.5	2.5	V
Drain-source on-resistance ⁽²⁾	R _{DS(on)}	V _{GS} =10V, I _D =10A		8.5	13	mΩ
		V _{GS} =4.5V, I _D =6A		13	19	
Forward tranconductance ⁽²⁾	g _{FS}	V _{DS} =10V, I _D =10A		10		S
Dynamic characteristics						
Input Capacitance	C _{iss}	V _{DS} =15V, V _{GS} =0V, f =1MHz		900		pF
Output Capacitance	C _{oss}			140		
Reverse Transfer Capacitance	C _{rss}			120		
Switching characteristics						
Turn-on delay time	t _{d(on)}	V _{DD} =15V, I _D =10A V _{GS} =10V, R _G =3Ω		6		ns
Turn-on rise time	t _r			5		
Turn-off delay time	t _{d(off)}			25		
Turn-off fall time	t _f			7		
Total Gate Charge	Q _g	V _{DS} =15V, I _D =20A, V _{GS} =10V		19		nC
Gate-Source Charge	Q _{gs}			6.3		
Gate-Drain Charge	Q _{gd}			4.5		
Source-Drain Diode characteristics						
Diode Forward voltage ⁽²⁾	V _{DS}	V _{GS} =0V, I _S =10A			1.2	V
Diode Forward current ⁽³⁾	I _S		-	-	36	A

Test Circuit

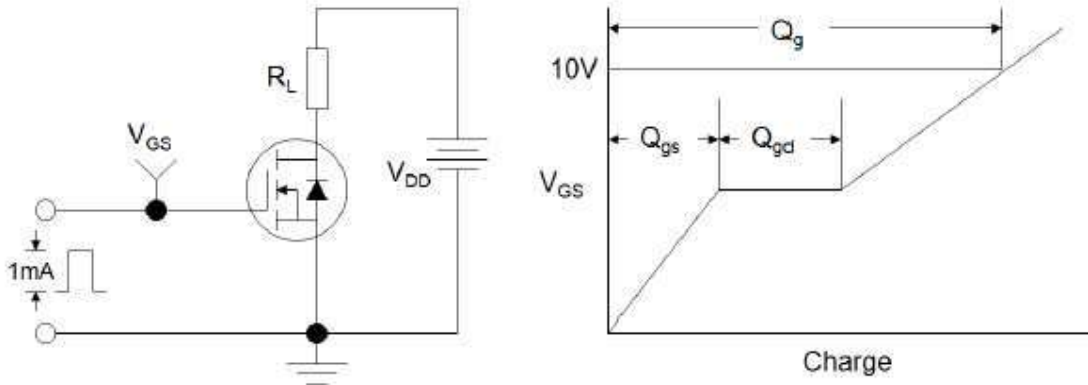

Figure1:Gate Charge Test Circuit & Waveform

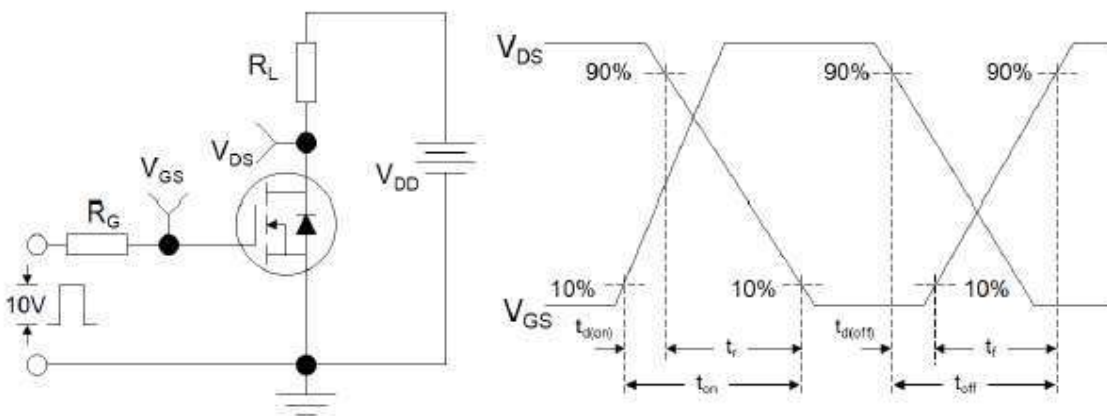

Figure 2: Resistive Switching Test Circuit & Waveforms

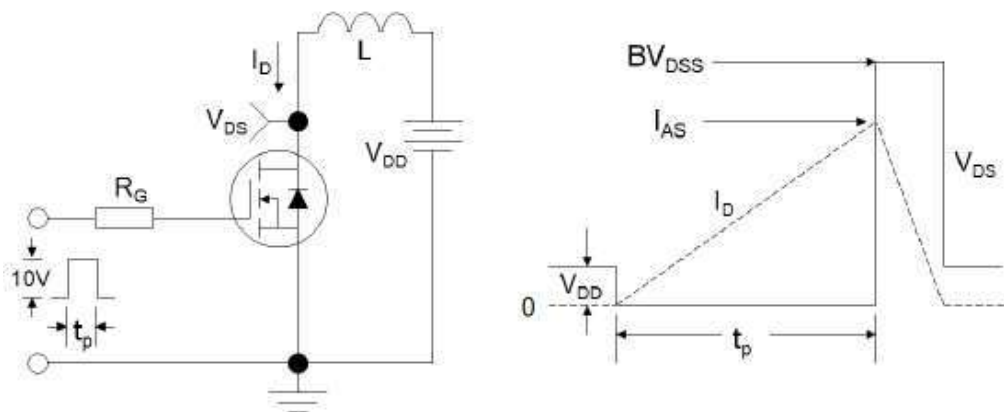

Figure 3:Unclamped Inductive Switching Test Circuit & Waveforms

Typical Performance Characteristics

Figure 1: Output Characteristics

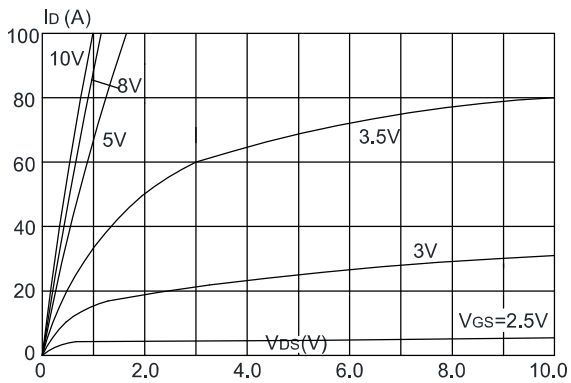

Figure 2: Typical Transfer Characteristics

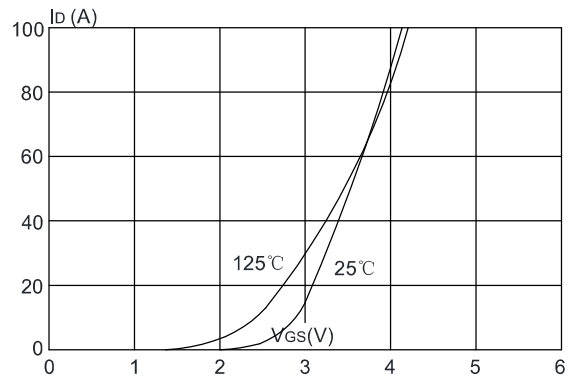

Figure 3: On-resistance vs. Drain Current

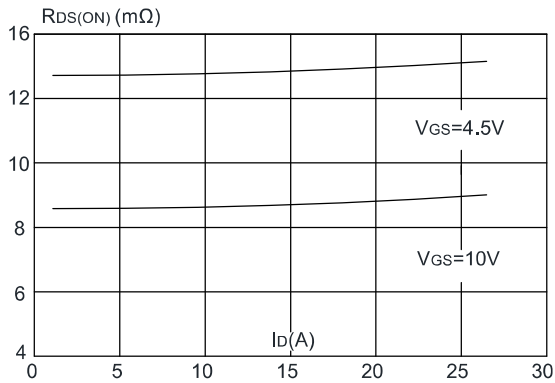

Figure 4: Body Diode Characteristics

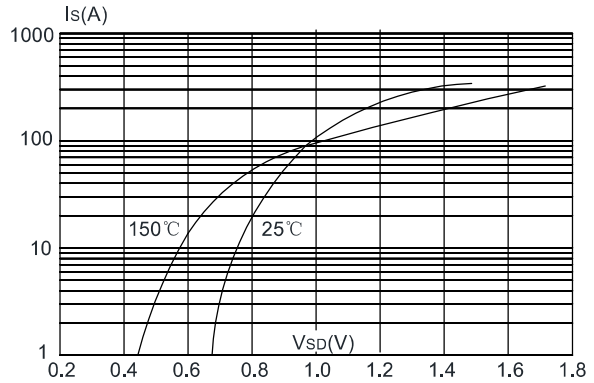

Figure 5: Gate Charge Characteristics

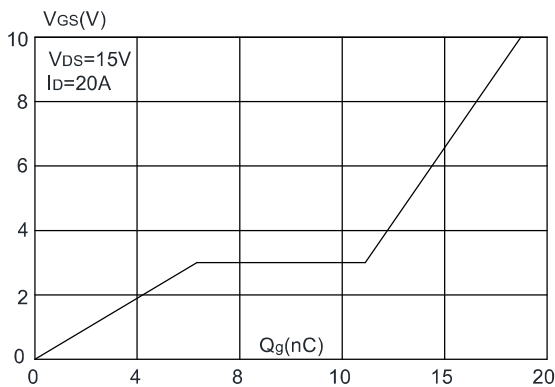

Figure 6: Capacitance Characteristics

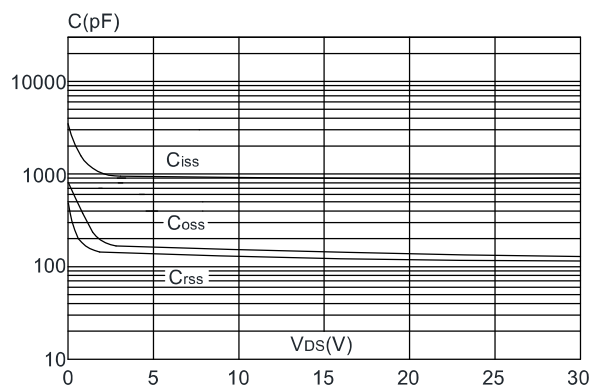

Figure 7: Normalized Breakdown Voltage vs. Junction Temperature

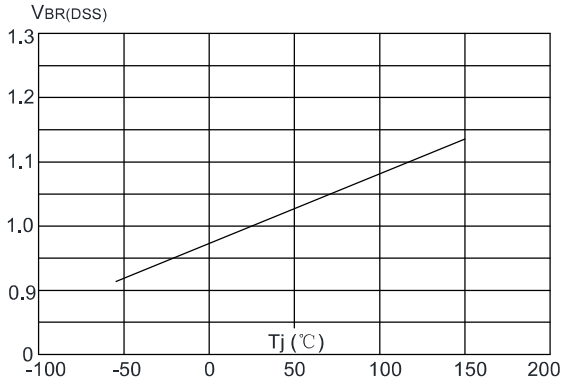

Figure 8: Normalized on Resistance vs. Junction Temperature

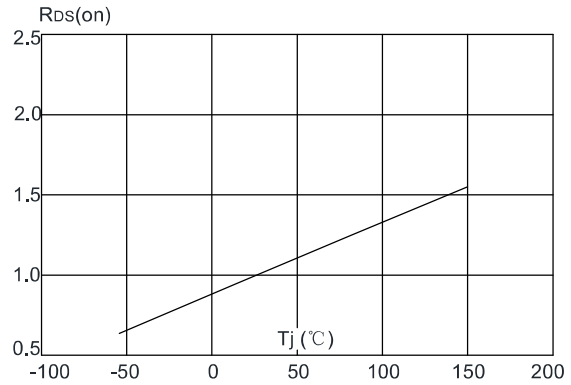

Figure 9: Maximum Safe Operating Area

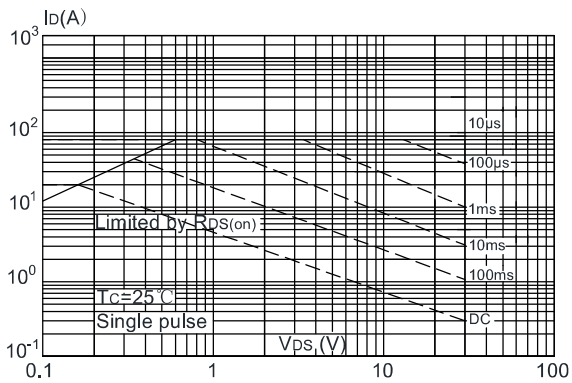

Figure 10: Maximum Continuous Drain Current vs. Case Temperature

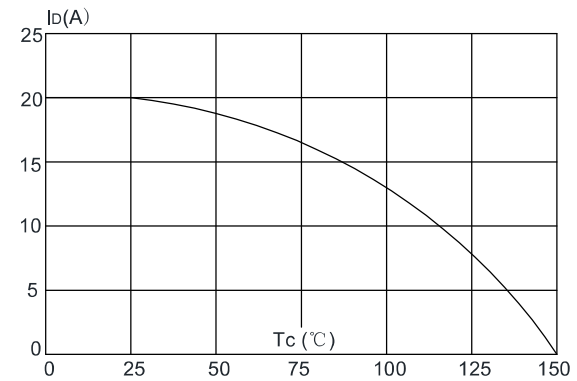
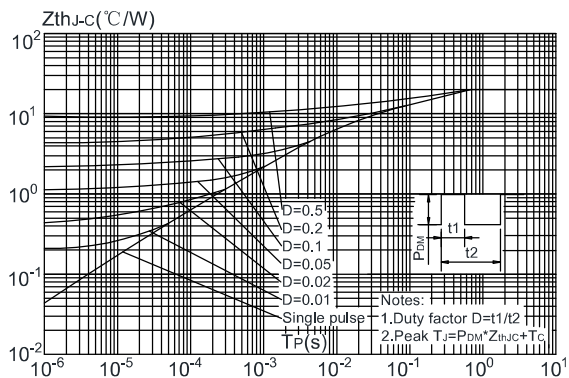

Figure.11: Maximum Effective Transient Thermal Impedance, Junction-to-Case



AP3908GD

N and P-Channel Enhancement Mosfet

AIIPOWER

DATA SHEET

P-CH ELECTRICAL CHARACTERISTICS($T_a=25^{\circ}\text{C}$ unless otherwise noted)

Parameter	Symbol	Test Condition	Min	Type	Max	Unit
Static Characteristics						
Drain-source breakdown voltage	$V_{(BR)DSS}$	$V_{GS} = 0V, I_D = -250\mu A$	-30			V
Zero gate voltage drain current	I_{DSS}	$V_{DS} = -30V, V_{GS} = 0V$			1	μA
Gate-body leakage current	I_{GSS}	$V_{GS} = \pm 20V, V_{DS} = 0V$			± 100	nA
Gate threshold voltage ⁽²⁾	$V_{GS(th)}$	$V_{DS} = V_{GS}, I_D = -250\mu A$	-1	-1.5	-2.5	V
Drain-source on-resistance ⁽²⁾	$R_{DS(on)}$	$V_{GS} = -10V, I_D = -10A$		16	23	m Ω
		$V_{GS} = -4.5V, I_D = -5A$		25	34	
Forward tranconductance ⁽²⁾	g_{FS}	$V_{DS} = -10V, I_D = -10A$		20		S
Dynamic characteristics						
Input Capacitance	C_{iss}	$V_{DS} = -15V, V_{GS} = 0V, f = 1MHz$		1550		pF
Output Capacitance	C_{oss}			327		
Reverse Transfer Capacitance	C_{rss}			278		
Switching characteristics						
Turn-on delay time	$t_{d(on)}$	$V_{DD} = -15V, I_D = -6A$ $V_{GS} = -10V, R_G = 2.5\Omega$		14		ns
Turn-on rise time	t_r			20		
Turn-off delay time	$t_{d(off)}$			95		
Turn-off fall time	t_f			65		
Total Gate Charge	Q_g	$V_{DS} = -15V, I_D = -10A,$ $V_{GS} = -10V$		30		nC
Gate-Source Charge	Q_{gs}			5.3		
Gate-Drain Charge	Q_{gd}			7.6		
Source-Drain Diode characteristics						
Diode Forward voltage ⁽²⁾	V_{DS}	$V_{GS} = 0V, I_S = -10A$			1.2	V
Diode Forward current ⁽³⁾	I_S		-	-	-20	A

Notes:

1. Repetitive Rating: pulse width limited by maximum junction temperature
2. Pulse Test: pulse width $\leq 300\mu s$, duty cycle $\leq 2\%$
3. Surface Mounted on FR4 Board, $t \leq 10$ sec

Gate Charge Test Circuit & Waveform

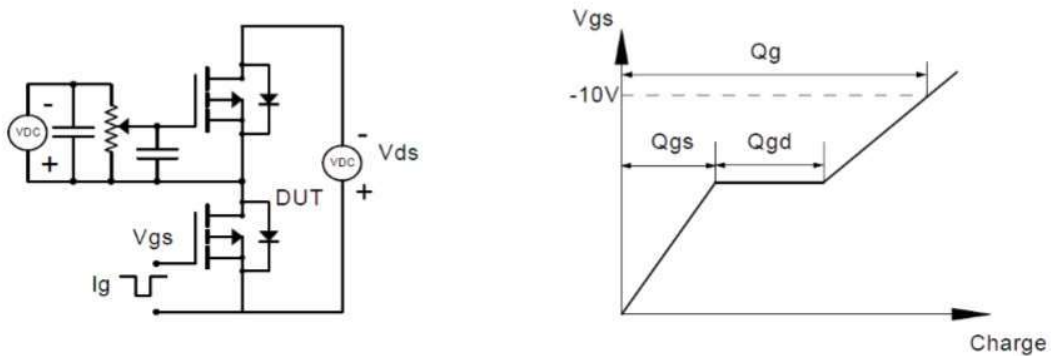

Resistive Switching Test Circuit & Waveforms

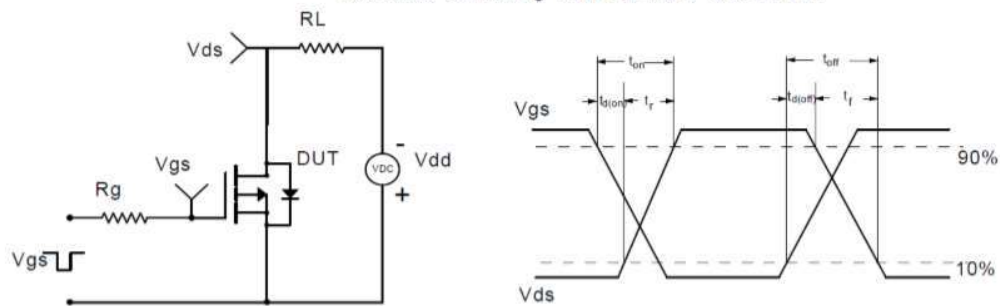

Unclamped Inductive Switching (UIS) Test Circuit & Waveforms

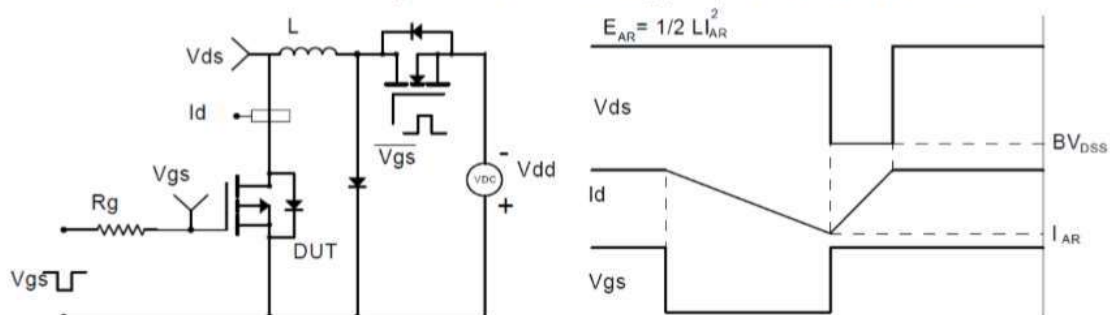

Diode Recovery Test Circuit & Waveforms

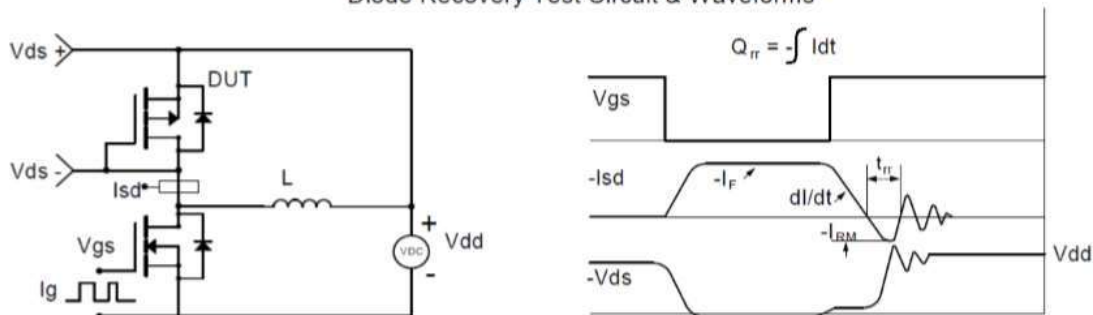

Figure 1: Output Characteristics

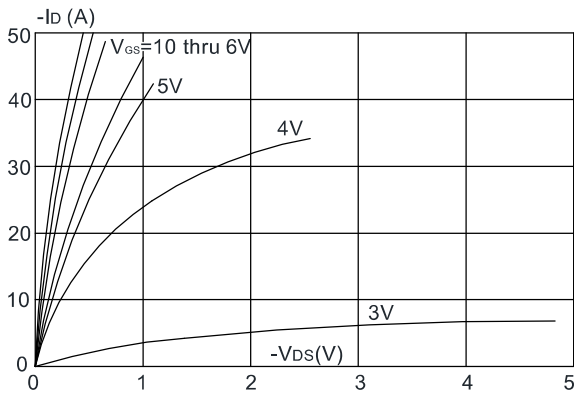

Figure 2: Typical Transfer Characteristics

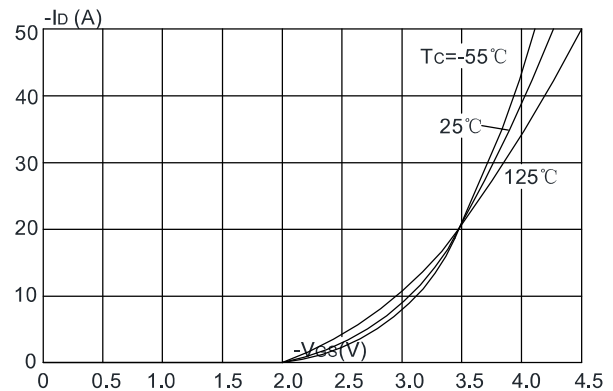

Figure 3: On-resistance vs. Drain Current

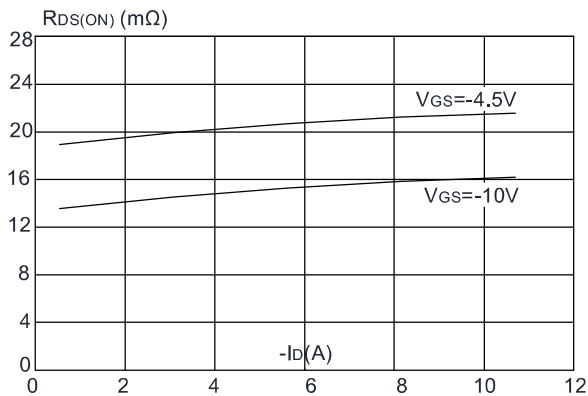

Figure 4: Body Diode Characteristics

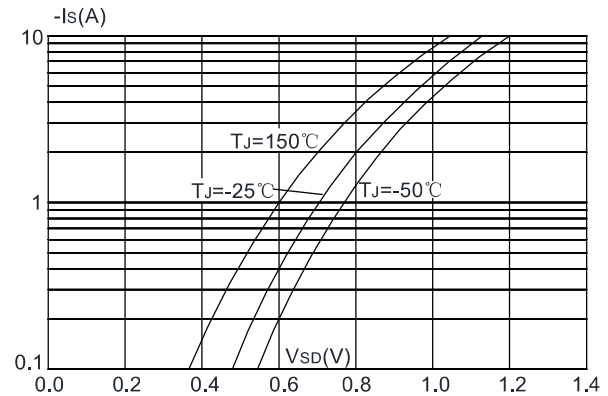

Figure 5: Gate Charge Characteristics

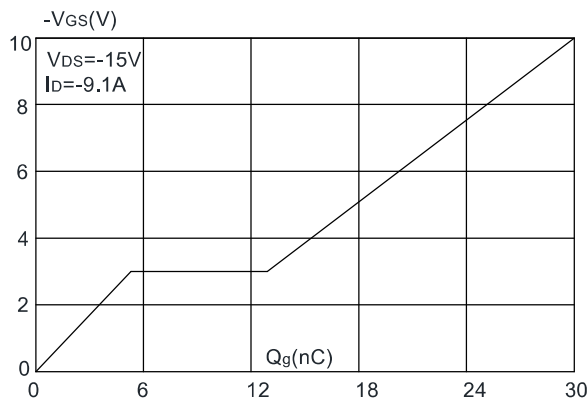

Figure 6: Capacitance Characteristics

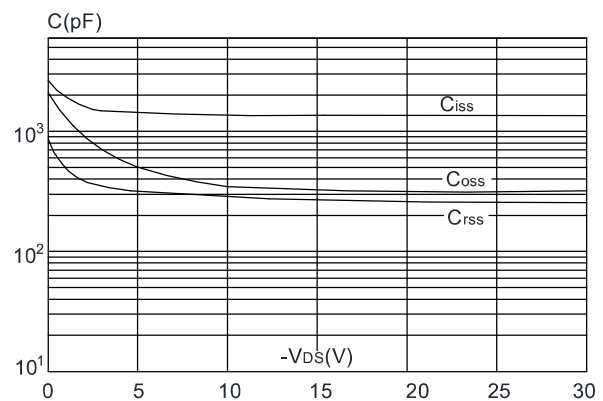

Figure 7: Normalized Breakdown Voltage vs. Junction Temperature

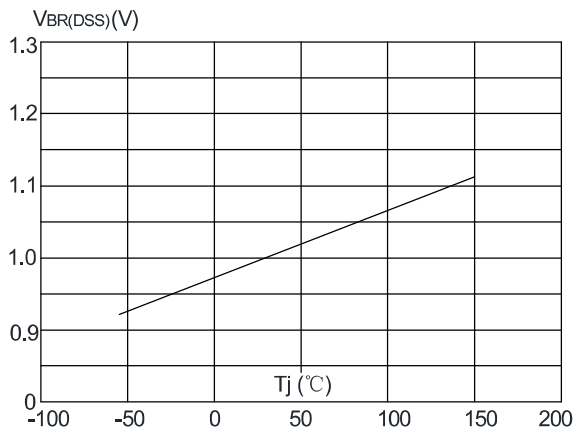

Figure 8: Normalized on Resistance vs. Junction Temperature

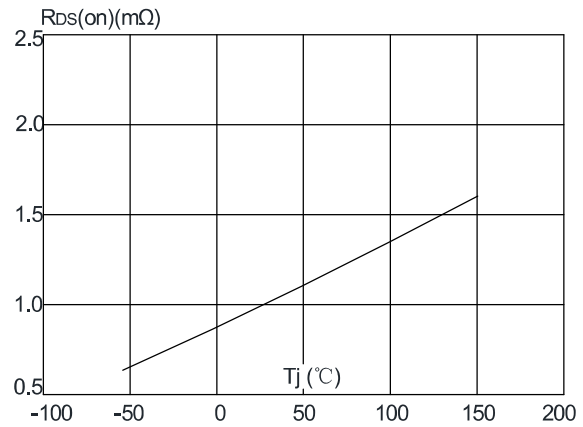

Figure 9: Maximum Safe Operating Area

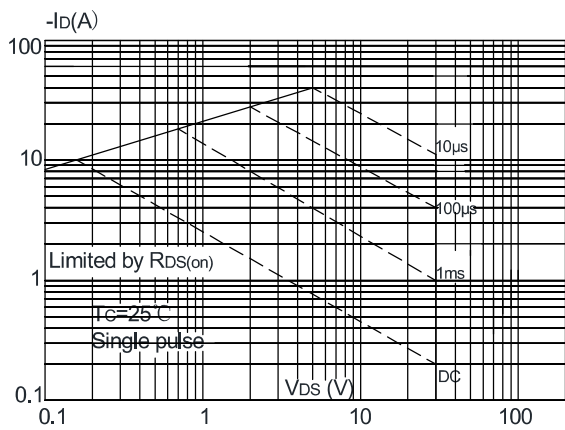

Figure 10: Maximum Continuous Drain Current vs. Case Temperature

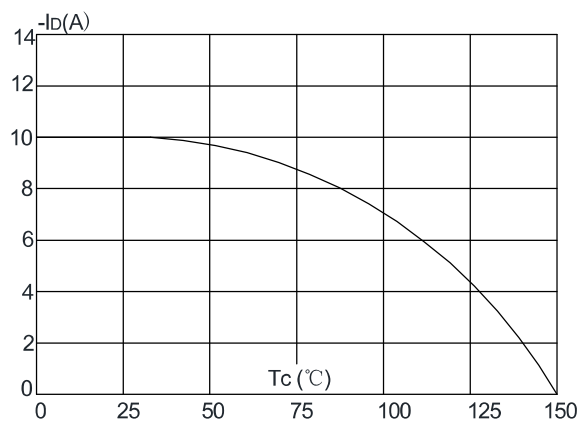
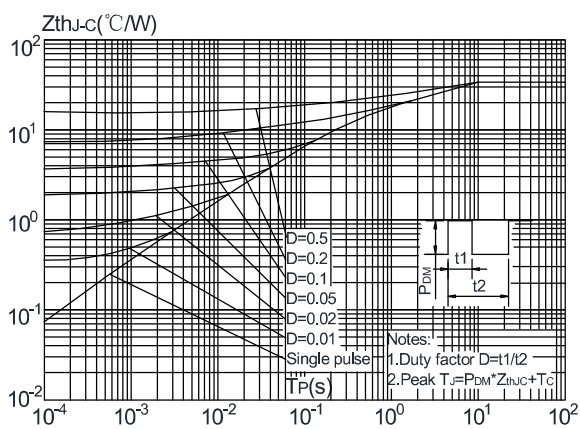
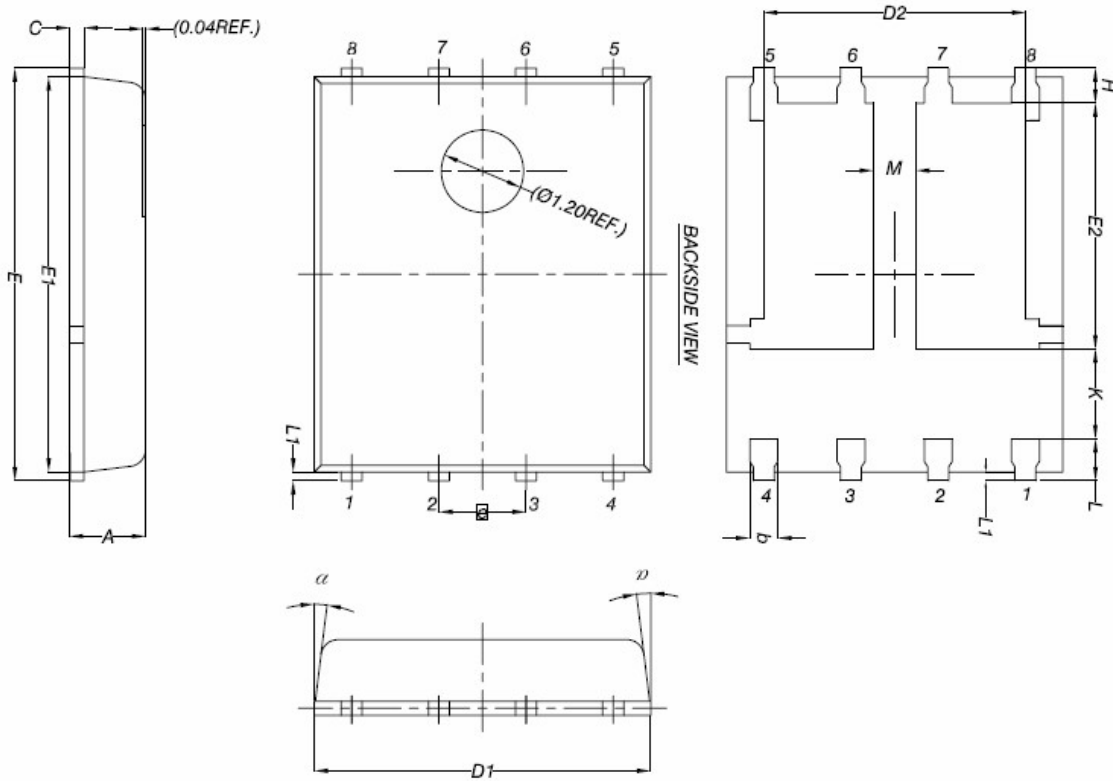

Figure.11: Maximum Effective Transient Thermal Impedance, Junction-to-Ambient



PDFN5X6-8L Package Information



DIM.	MILLIMETERS		
	MIN.	NOM.	MAX.
A	0.90	1.00	1.10
b	0.33	0.41	0.51
C	0.20	0.25	0.30
D1	4.80	4.90	5.00
D2	3.61	3.81	3.96
E	5.90	6.00	6.10
E1	5.70	5.75	5.80
E2	3.38	3.58	3.78
e	1.27 BSC		
H	0.41	0.51	0.61
K	1.10	-	-
L	0.51	0.61	0.71
L1	0.06	0.13	0.20
M	0.50	-	-
α	0°	-	12°