

Feature

- 40V,70A
 $R_{DS(ON)} < 5.9m\Omega @ V_{GS}=10V$ TYP 5.0 m Ω
 $R_{DS(ON)} < 10m\Omega @ V_{GS}=4.5V$ TYP 7.5 m Ω
- Advanced Trench Technology
- Lead free product is acquired
- Excellent $R_{DS(ON)}$ and Low Gate Charge

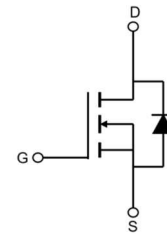

Schematic Diagram



Marking and pin assignment

Application

- PWM applications
- Load Switch
- Power management

Package Marking and Ordering Information

Device Marking	Device	Device Package	Reel Size	Tape width	Quantity (PCS)
85N04K	AP85N04K	TO-252	13 inch	-	2500

ABSOLUTE MAXIMUM RATINGS ($T_a=25^{\circ}C$ unless otherwise noted)

Parameter	Symbol	Value	Unit
Drain-Source Voltage	V_{DS}	40	V
Gate-Source Voltage	V_{GS}	± 20	V
Continuous Drain Current ($T_c = 25^{\circ}C$)	I_D	70	A
Continuous Drain Current ($T_c = 100^{\circ}C$)	I_D	46	A
Pulsed Drain Current ⁽¹⁾	I_{DM}	260	A
Single Pulsed Avalanche Energy ⁽²⁾	E_{AS}	96	mJ
Power Dissipation	P_D	58	W
Thermal Resistance from Junction to Case ⁽⁴⁾	$R_{\theta JC}$	2.6	$^{\circ}C/W$
Junction Temperature	T_J	150	$^{\circ}C$
Storage Temperature	T_{STG}	-55~ +150	$^{\circ}C$

MOSFET ELECTRICAL CHARACTERISTICS($T_a=25^\circ\text{C}$ unless otherwise noted)

Parameter	Symbol	Test Condition	Min	Type	Max	Unit
Static Characteristics						
Drain-source breakdown voltage	$V_{(BR)DSS}$	$V_{GS} = 0V, I_D = 250\mu A$	40	-	-	V
Zero gate voltage drain current	I_{DSS}	$V_{DS} = 40V, V_{GS} = 0V$	-	-	1	μA
Gate-body leakage current	I_{GSS}	$V_{GS} = \pm 20V, V_{DS} = 0V$	-	-	± 100	nA
Gate threshold voltage ⁽³⁾	$V_{GS(th)}$	$V_{DS} = V_{GS}, I_D = 250\mu A$	1	1.5	2.5	V
Drain-source on-resistance ⁽³⁾	$R_{DS(on)}$	$V_{GS} = 10V, I_D = 30A$	-	5.0	5.9	m Ω
		$V_{GS} = 4.5V, I_D = 20A$	-	7.5	10	
Dynamic characteristics						
Input Capacitance	C_{iss}	$V_{DS} = 20V, V_{GS} = 0V, f = 1MHz$	-	2956	-	pF
Output Capacitance	C_{oss}		-	225	-	
Reverse Transfer Capacitance	C_{rss}		-	197	-	
Switching characteristics						
Turn-on delay time	$t_{d(on)}$	$V_{DD} = 20V, I_D = 30A, R_L = 1\Omega$ $V_{GS} = 10V, R_G = 3\Omega$	-	8	-	ns
Turn-on rise time	t_r		-	16	-	
Turn-off delay time	$t_{d(off)}$		-	21	-	
Turn-off fall time	t_f		-	10	-	
Total Gate Charge	Q_g	$V_{DS} = 20V, I_D = 30A,$ $V_{GS} = 10V$	-	46	-	nC
Gate-Source Charge	Q_{gs}		-	7.2	-	
Gate-Drain Charge	Q_{gd}		-	8.8	-	
Source-Drain Diode characteristics						
Diode Forward voltage ⁽³⁾	V_{DS}	$V_{GS} = 0V, I_S = 1A$	-	-	1.2	V
Diode Forward current ⁽⁴⁾	I_S		-	-	65	A

Notes:

1. Repetitive Rating: pulse width limited by maximum junction temperature
2. EAS Condition: $T_J = 25^\circ\text{C}, V_{DD} = 20V, R_G = 25\Omega, L = 0.5mH$
3. Pulse Test: pulse width $\leq 300\mu s$, duty cycle $\leq 2\%$
4. Surface Mounted on FR4 Board, $t \leq 10$ sec

Test Circuit

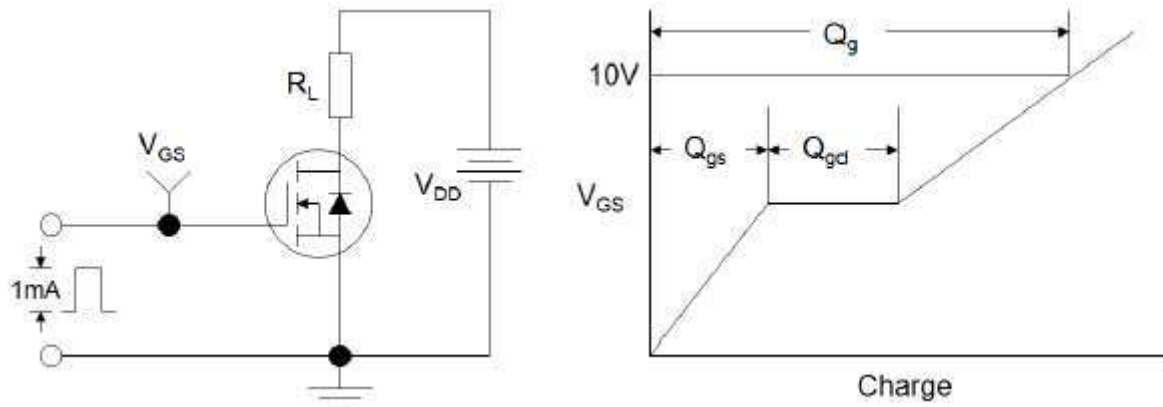

Figure1:Gate Charge Test Circuit & Waveform

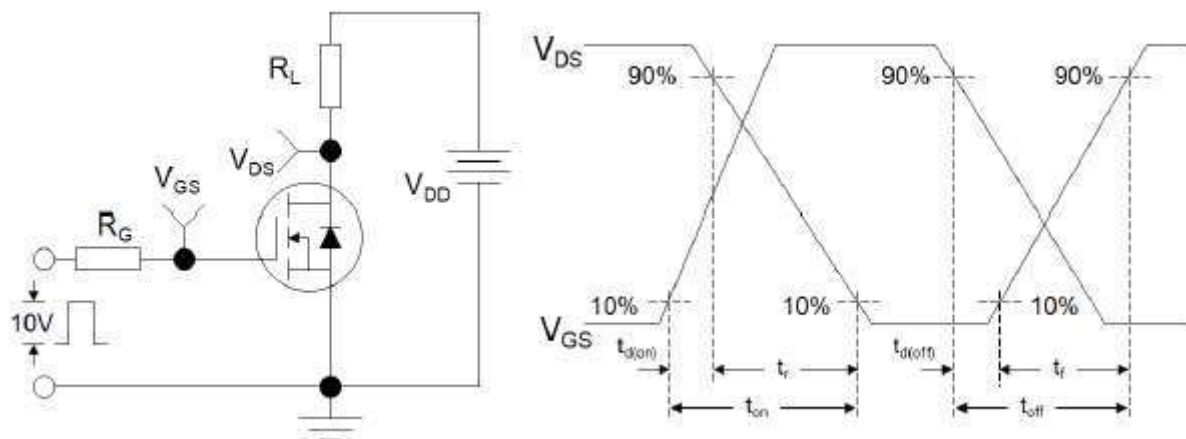

Figure 2: Resistive Switching Test Circuit & Waveforms

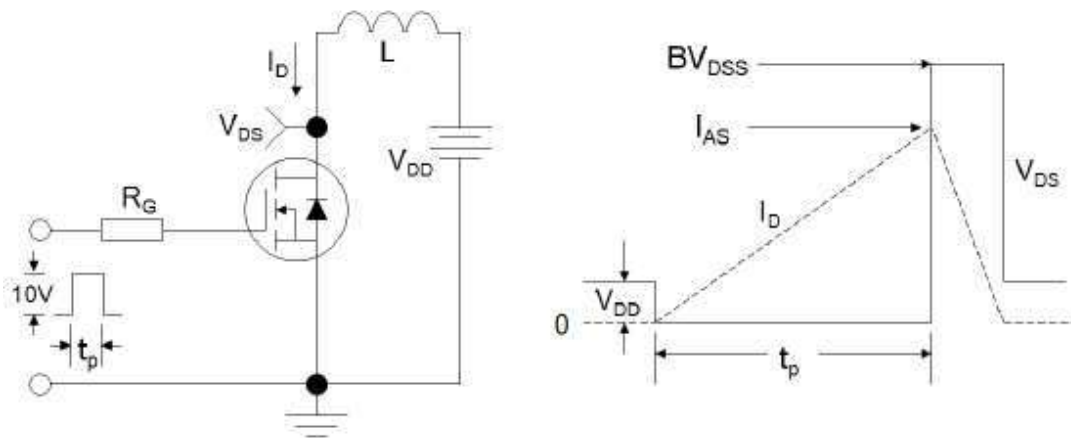

Figure 3:Unclamped Inductive Switching Test Circuit & Waveforms

Figure 1: Output Characteristics

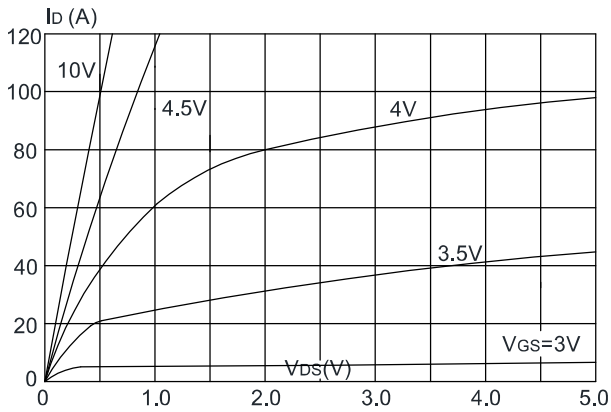

Figure 2: Typical Transfer Characteristics

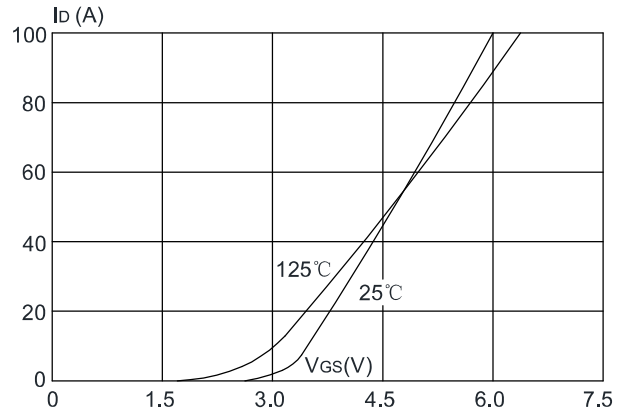

Figure 3: On-resistance vs. Drain Current

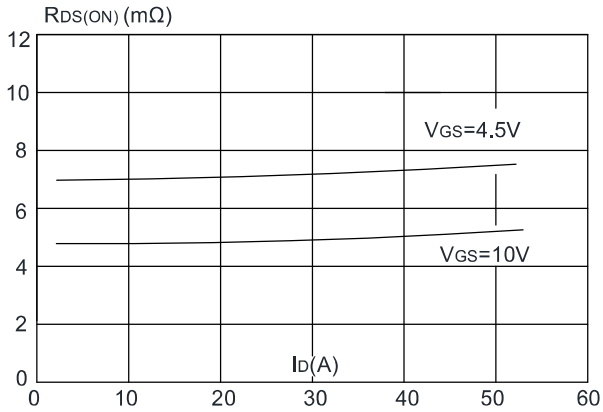

Figure 4: Body Diode Characteristics

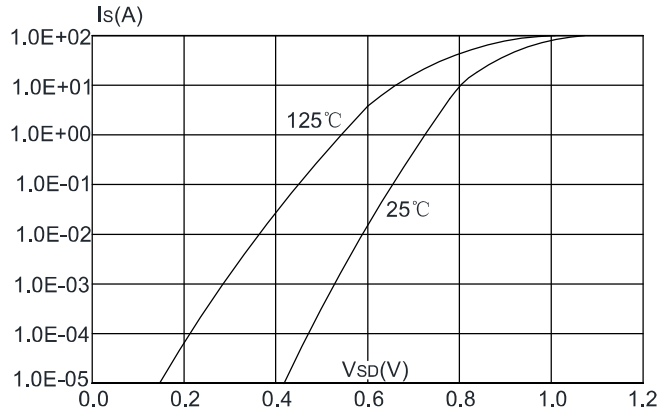

Figure 5: Gate Charge Characteristics

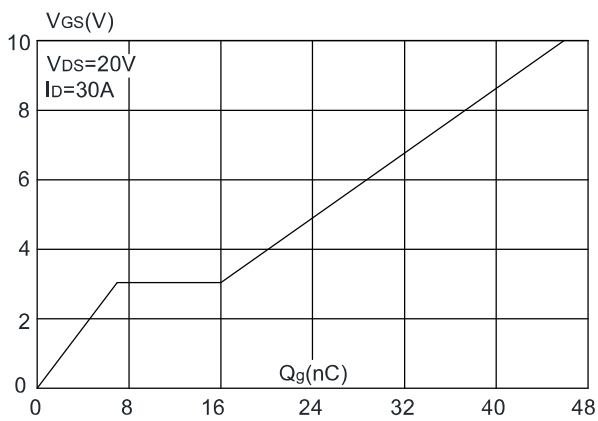
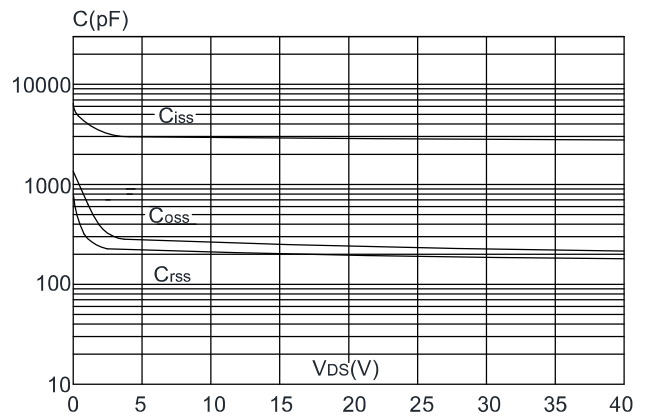

Figure 6: Capacitance Characteristics



AP85N04K

N-Channel Enhancement Mosfet

Figure 7: Normalized Breakdown Voltage vs. Junction Temperature

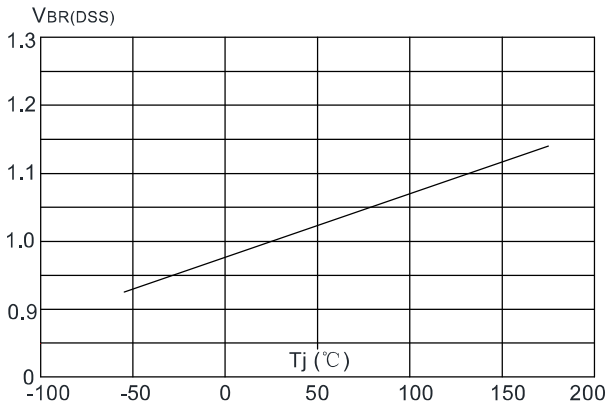

Figure 8: Normalized on Resistance vs. Junction Temperature

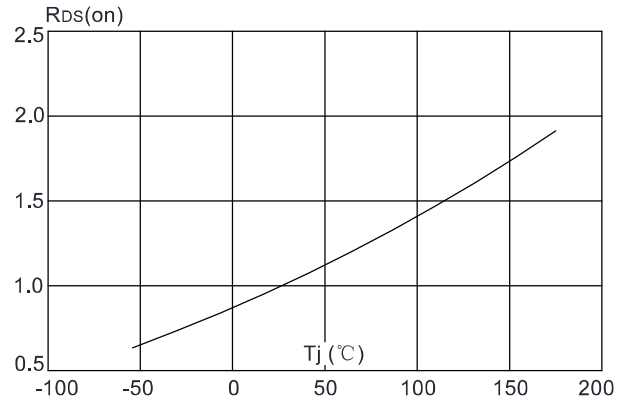

Figure 9: Maximum Safe Operating Area

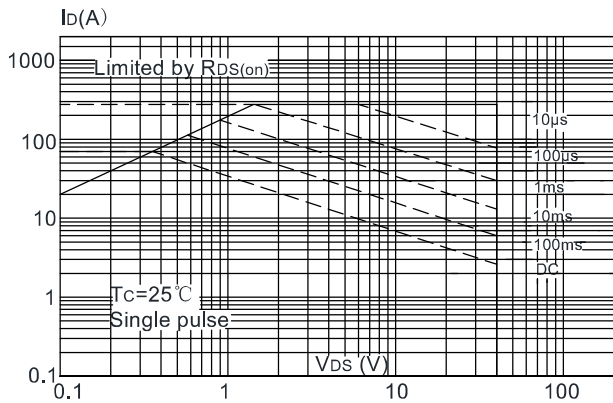

Figure 10: Maximum Continuous Drain Current vs. Case Temperature

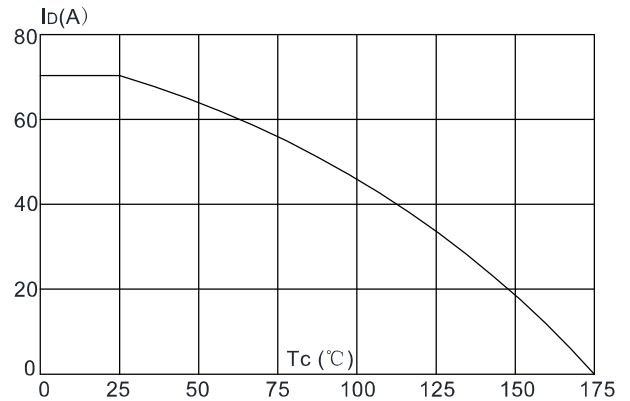
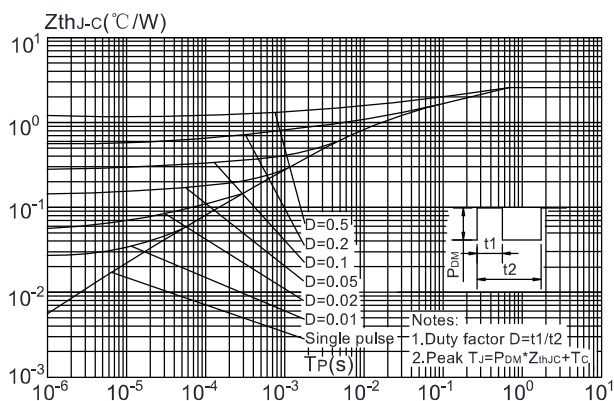
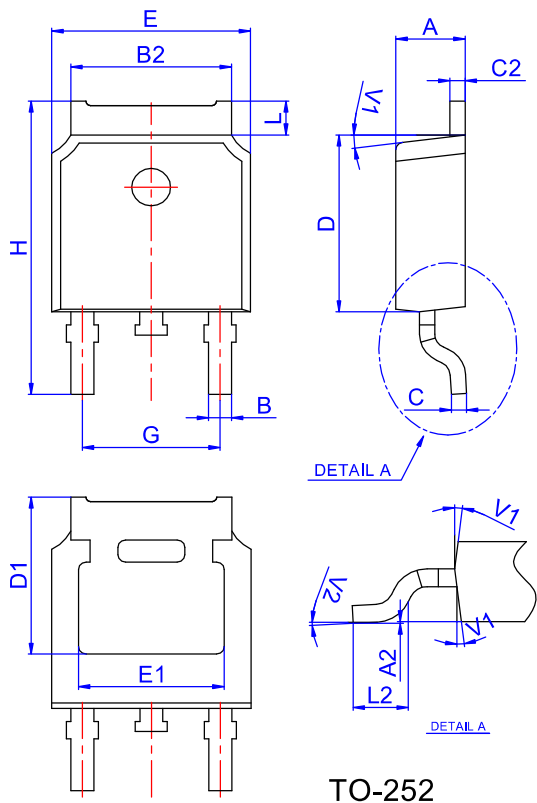

Figure.11: Maximum Effective Transient Thermal Impedance, Junction-to-Case



TO-252 Package Information



Ref.	Dimensions					
	Millimeters			Inches		
	Min.	Typ.	Max.	Min.	Typ.	Max.
A	2.10		2.50	0.083		0.098
A2	0		0.10	0		0.004
B	0.66		0.86	0.026		0.034
B2	5.18		5.48	0.202		0.216
C	0.40		0.60	0.016		0.024
C2	0.44		0.58	0.017		0.023
D	5.90		6.30	0.232		0.248
D1	5.30REF			0.209REF		
E	6.40		6.80	0.252		0.268
E1	4.63			0.182		
G	4.47		4.67	0.176		0.184
H	9.50		10.70	0.374		0.421
L	1.09		1.21	0.043		0.048
L2	1.35		1.65	0.053		0.065
V1		7°			7°	
V2	0°		6°	0°		6°

Reel Specification-TO-252

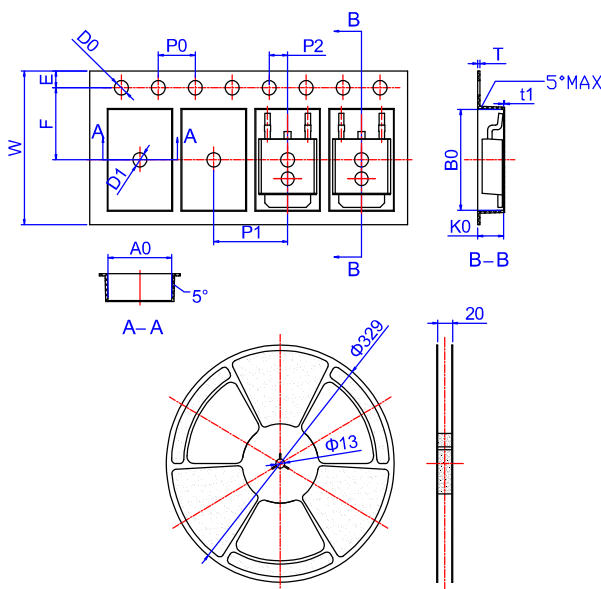

Ref.	Dimensions					
	Millimeters			Inches		
	Min.	Typ.	Max.	Min.	Typ.	Max.
W	15.90	16.00	16.10	0.626	0.630	0.634
E	1.65	1.75	1.85	0.065	0.069	0.073
F	7.40	7.50	7.60	0.291	0.295	0.299
D0	1.40	1.50	1.60	0.055	0.059	0.063
D1	1.40	1.50	1.60	0.055	0.059	0.063
P0	3.90	4.00	4.10	0.154	0.157	0.161
P1	7.90	8.00	8.10	0.311	0.315	0.319
P2	1.90	2.00	2.10	0.075	0.079	0.083
A0	6.85	6.90	7.00	0.270	0.271	0.276
B0	10.45	10.50	10.60	0.411	0.413	0.417
K0	2.68	2.78	2.88	0.105	0.109	0.113
T	0.24		0.27	0.009		0.011
t1	0.10			0.004		
10P0	39.80	40.00	40.20	1.567	1.575	1.583