

AP2N7002

N-Channel Enhancement Mosfet

Feature

- 60V,0.3A
 $R_{DS(ON)} < 2.2 \Omega @ V_{GS}=10V$ TYP:1.8 Ω
 $R_{DS(ON)} < 2.6 \Omega @ V_{GS}=4.5V$ TYP:2.2 Ω
- Advanced TrenchTechnology
- Lead free product is acquired
- ESD Protected Up to 2.0KV(HBM)

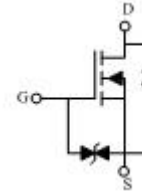

Schematic diagram

Application

- Networking
- Load Switching
- Logic Level shift

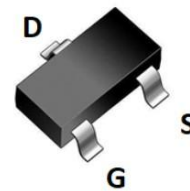

SOT-23

Package Marking and Ordering Information

Device Marking	Device	Device Package	Reel Size	Tape width	Quantity (PCS)
7002K	AP2N7002	SOT-23	7 inch	-	3000

ABSOLUTE MAXIMUM RATINGS ($T_J=25^\circ\text{C}$ unless otherwise noted)

Parameter	Symbol	Value	Unit
Drain-Source Voltage	V_{DS}	60	V
Gate-Source Voltage	V_{GS}	± 20	V
Continuous Drain Current ($T_a=25^\circ\text{C}$)	I_D	0.3	A
Continuous Drain Current ($T_a=100^\circ\text{C}$)	I_D	0.2	A
Pulsed Drain Current	I_{DM}	1.2	A
Power Dissipation	P_D	0.35	W
Thermal Resistance from Junction to Ambient ⁽⁴⁾	$R_{\theta JA}$	356	$^\circ\text{C}/\text{W}$
Junction Temperature	T_J	150	$^\circ\text{C}$
Storage Temperature	T_{STG}	-55~ +150	$^\circ\text{C}$

MOSFET ELECTRICAL CHARACTERISTICS($T_J=25^{\circ}\text{C}$ unless otherwise noted)

Parameter	Symbol	Test Condition	Min	Type	Max	Unit
Static Characteristics						
Drain-source breakdown voltage	$V_{(BR)DSS}$	$V_{GS} = 0V, I_D = 250\mu A$	60	-	-	V
Zero gate voltage drain current	I_{DSS}	$V_{DS} = 60V, V_{GS} = 0V$	-	-	1	μA
Gate-body leakage current	I_{GSS}	$V_{GS} = \pm 20V, V_{DS} = 0V$	-	-	± 10	μA
Gate threshold voltage ⁽³⁾	$V_{GS(th)}$	$V_{DS} = V_{GS}, I_D = 250\mu A$	1.0	1.6	2.5	V
Drain-source on-resistance ⁽³⁾	$R_{DS(on)}$	$V_{GS} = 10V, I_D = 0.1A$	-	1.8	2.2	Ω
		$V_{GS} = 4.5V, I_D = 0.1A$	-	2.2	2.6	
Dynamic characteristics						
Input Capacitance	C_{iss}	$V_{DS} = 10V, V_{GS} = 0V, f = 1MHz$	-	28	-	pF
Output Capacitance	C_{oss}		-	11	-	
Reverse Transfer Capacitance	C_{rss}		-	4	-	
Switching characteristics						
Turn-on delay time	$t_{d(on)}$	$V_{DD} = 10V, I_D = 0.2A,$ $V_{GS} = 10V, R_G = 3.3\Omega$	-	2	-	ns
Turn-on rise time	t_r		-	15	-	
Turn-off delay time	$t_{d(off)}$		-	7	-	
Turn-off fall time	t_f		-	20	-	
Total Gate Charge	Q_g	$V_{DS} = 30V, I_D = 0.3A,$ $V_{GS} = 10V$	-	1.7	-	nC
Gate-Source Charge	Q_{gs}		-	0.3	-	
Gate-Drain Charge	Q_{gd}		-	0.6	-	
Source-Drain Diode characteristics						
Diode Forward voltage ⁽³⁾	V_{DS}	$V_{GS} = 0V, I_S = 0.3A$	-	-	1.2	V
Diode Forward current ⁽⁴⁾	I_S		-	-	0.3	A

Notes:

1. Repetitive Rating: pulse width limited by maximum junction temperature
2. Pulse Test: pulse width $\leq 300\mu s$, duty cycle $\leq 2\%$
3. Surface Mounted on FR4 Board, $t_s \leq 10$ sec

Test Circuit

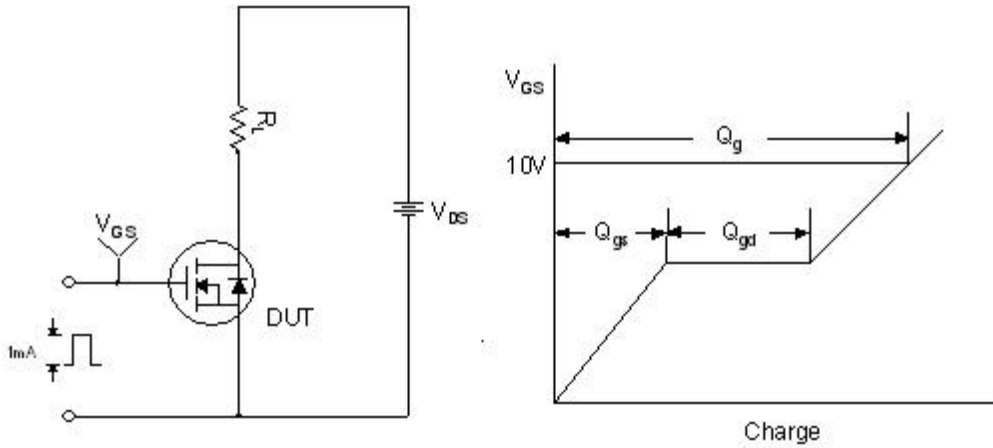

Figure 1. Gate Charge Test Circuit & Waveform

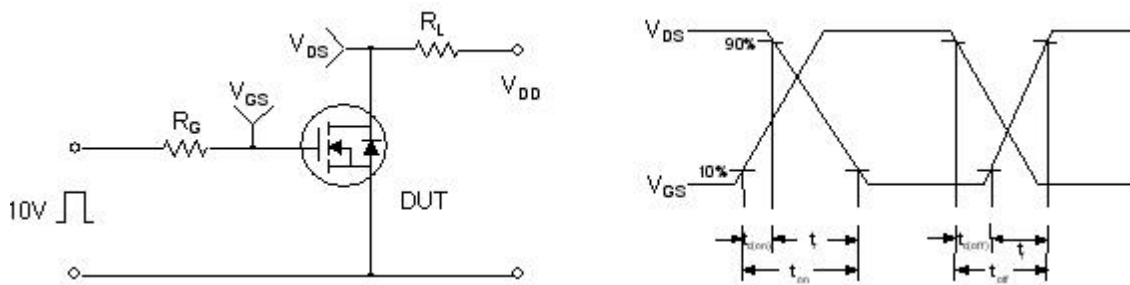

Figure 2. Resistive Switching Test Circuit & Waveforms

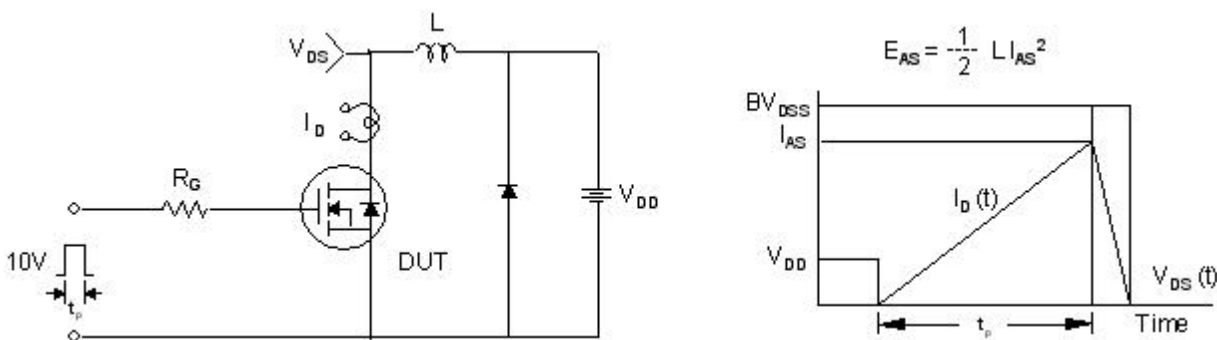

Figure 3. Unclamped Inductive Switching Test Circuit & Waveforms

Typical Performance Characteristics

Figure 1: Output Characteristics

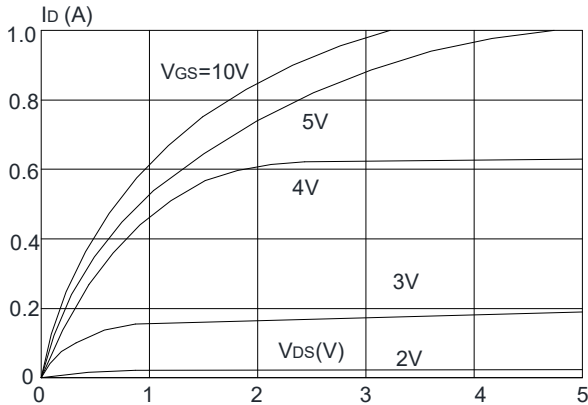

Figure 2: Typical Transfer Characteristics

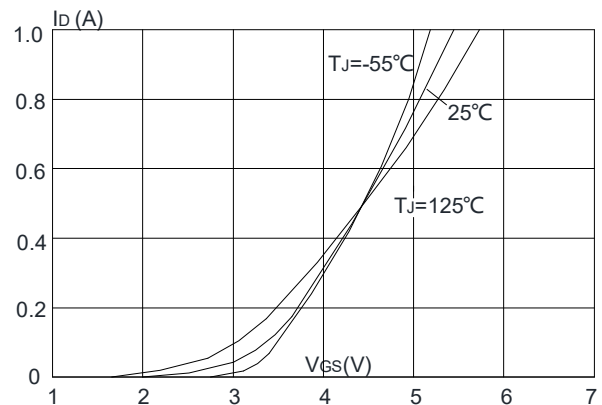

Figure 3: On-resistance vs. Drain Current

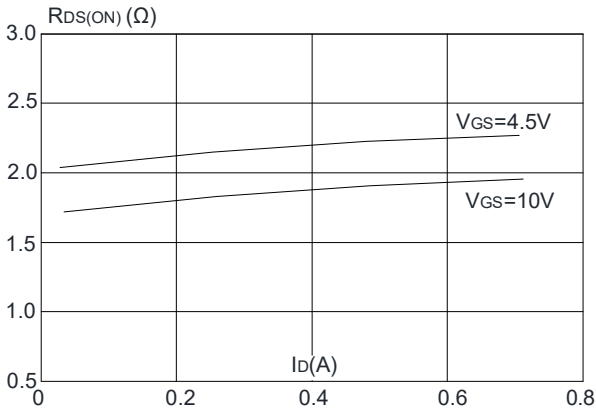

Figure 4: Body Diode Characteristics

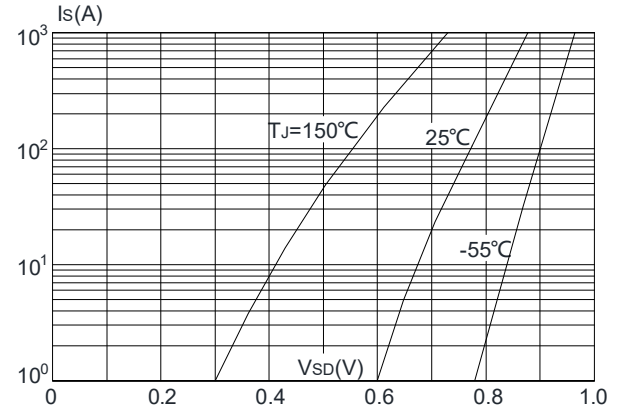

Figure 5: Gate Charge Characteristics

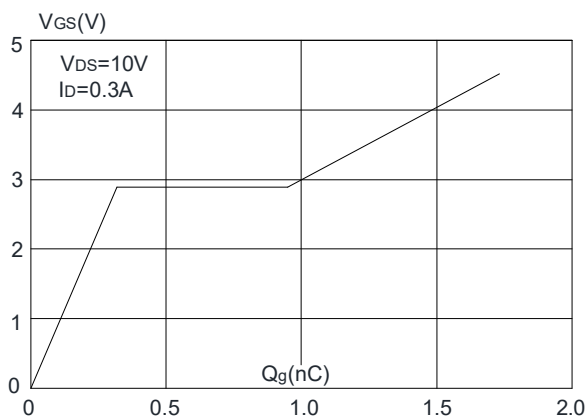

Figure 6: Capacitance Characteristics

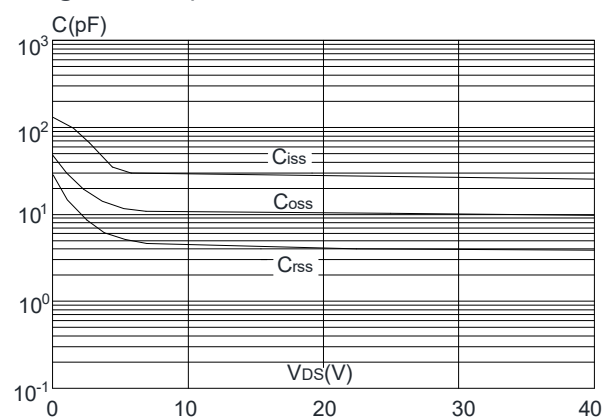

Figure 7: Normalized Breakdown Voltage vs. Junction Temperature

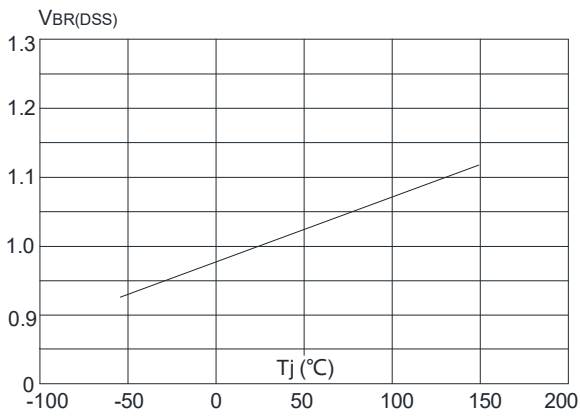

Figure 8: Normalized on Resistance vs. Junction Temperature

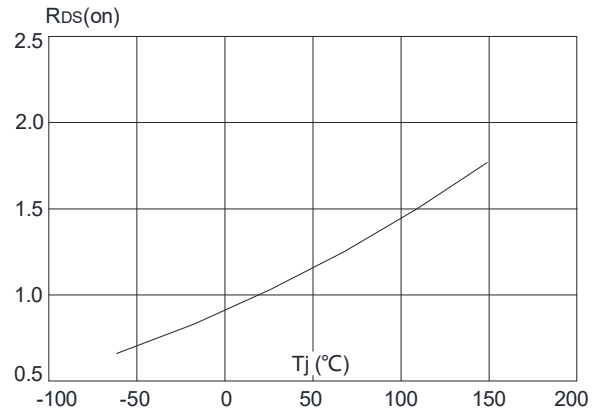

Figure 9: Maximum Safe Operating Area

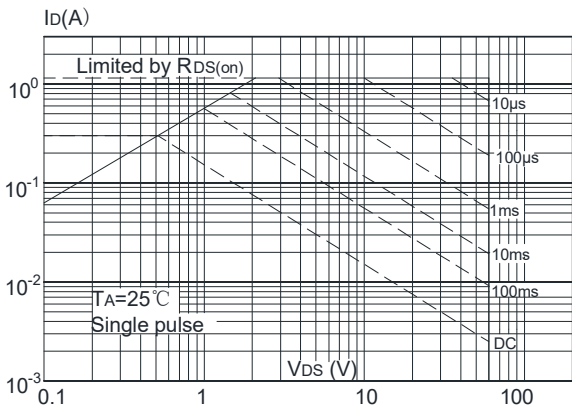

Figure 10: Maximum Continuous Drain Current vs. Ambient Temperature

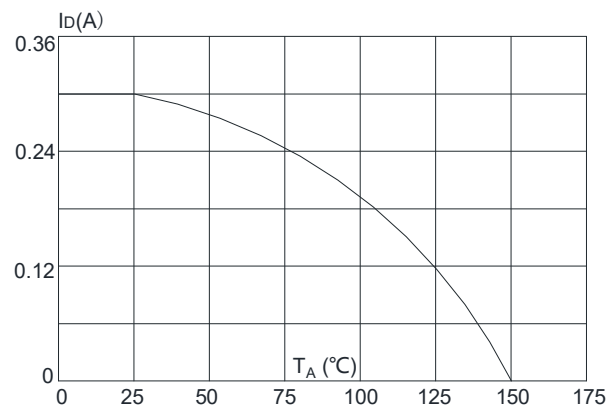
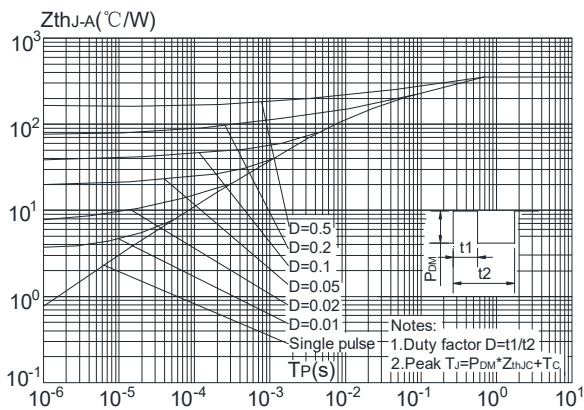

Figure.11: Maximum Effective Transient Thermal Impedance, Junction-to-Ambient



Package Information

SOT-23

单位; mm

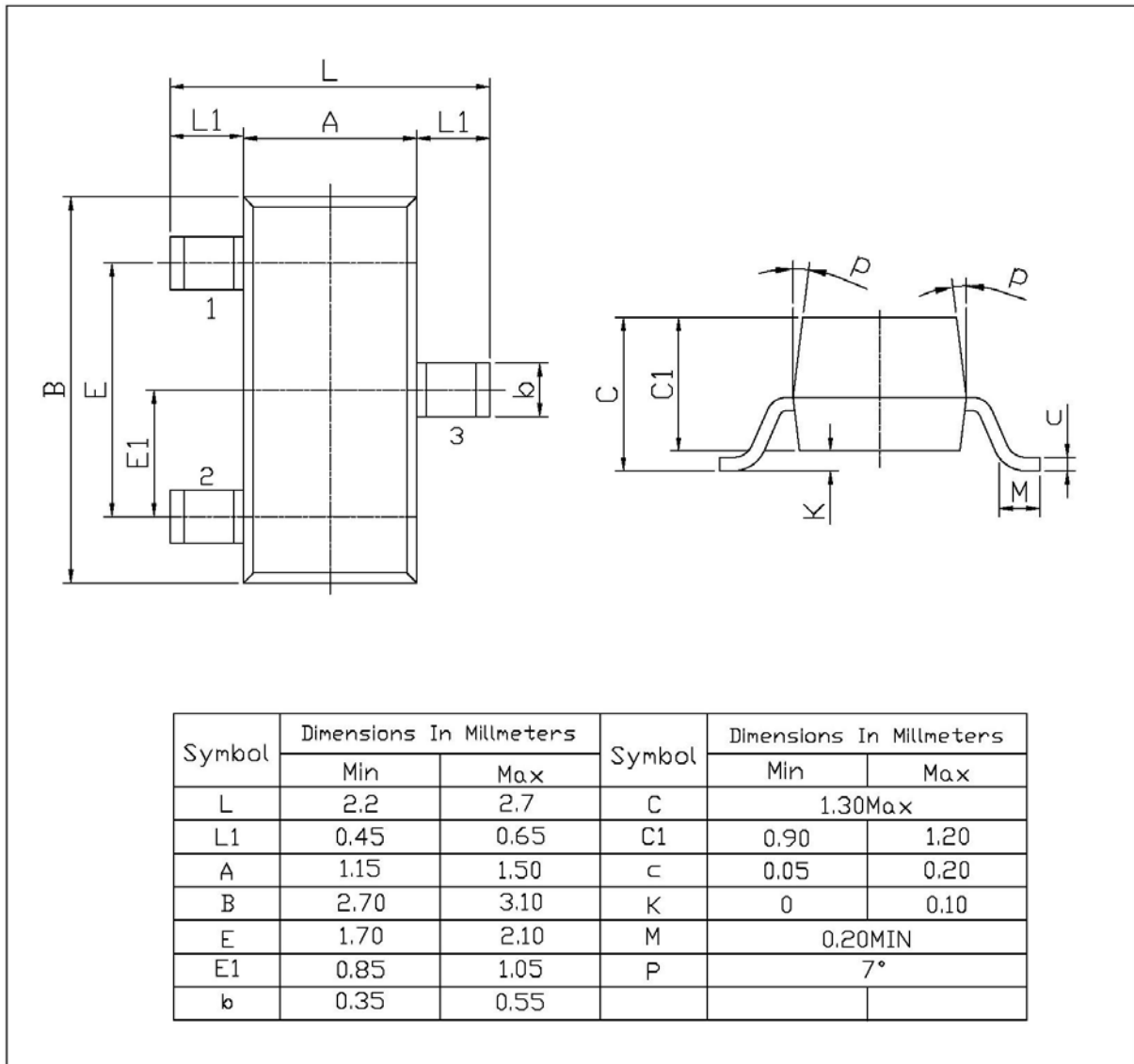

Revision History

Revision	Release	Remark
V1.0	2023/06/20	Initial Release

Disclaimer

The information given in this document describes the independent performance of the product, but similar performance is not guaranteed under other working conditions, and cannot be guaranteed when installed with other products or equipment. To achieve the required performance of the product in actual scenarios, the customer should conduct a complete application test to assess the functionality of the product.

Allpower assumes no responsibility for equipment failures result from using products at values that exceed the ratings, operating conditions, or other parameters listed in the product specifications.

The product described in this specification is not applicable for aerospace or other applications which requires high reliability. Customers using or selling these products for use in medical, life-saving, or life-sustaining applications do so at their own risk and agree to fully indemnify.

Due to product or technical improvements, the information described or contained herein may be changed without prior notice.