

APG032N12T

N-Channel Enhancement Mosfet

Features

- 120V,211A
 $R_{DS(ON)} < 3.2m\ \Omega @ V_{GS}=10V$ TYP:2.8m Ω
 $R_{DS(ON)} < 3.9m\ \Omega @ V_{GS}=6V$ TYP:3.4m Ω
- Surface-mounted package
- Super Trench

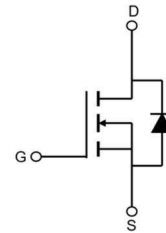

Schematic Diagram

Applications

- High power inverter system
- LCD TV appliances
- LCDM appliances

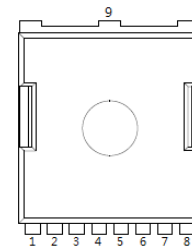

TOLL-8L

1	Gate(G)
2,3,4,5,6,7,8	Source(S)
9	Drain(D)

Package Marking and Ordering Information

Device Marking	Device	Device Package	Reel Size	Tape width	Quantity (PCS)
G032N12T	APG032N12T	TOLL-8L	-	-	2000

ABSOLUTE MAXIMUM RATINGS ($T_J=25^{\circ}C$ unless otherwise noted)

Parameter	Symbol	Value	Unit
Drain-Source Voltage	V_{DS}	120	V
Gate-Source Voltage	V_{GS}	± 20	V
Continuous Drain Current ($T_c=25^{\circ}C$) ⁽¹⁾	I_D	211	A
Continuous Drain Current ($T_c=100^{\circ}C$) ⁽¹⁾	I_D	149	A
Pulsed Drain Current ^(1,2)	I_{DM}	700	A
Single Pulsed Avalanche Energy ($T_c=25^{\circ}C, L=0.5mH$) ⁽¹⁾	E_{AS}	1800	mJ
Drain Power Dissipation ⁽¹⁾	P_D	375	W
Thermal Resistance from Junction to Case ⁽¹⁾	$R_{\theta JC}$	0.4	$^{\circ}C/W$
Thermal Resistance- Junction to Ambient ⁽¹⁾	$R_{\theta JA}$	50	$^{\circ}C/W$
Junction Temperature	T_J	175	$^{\circ}C$
Storage Temperature	T_{STG}	-55~ +175	$^{\circ}C$

Notes:

- 1 Surface Mounted on 1 in² pad area, $t \leq 10$ sec
- 2 Pulse width $\leq 300\mu s$, duty cycle $\leq 2\%$
- 3 Limited by bonding wire

MOSFET ELECTRICAL CHARACTERISTICS(T_J=25°C unless otherwise noted)

Parameter	Symbol	Test Condition	Min	Type	Max	Unit
Static Characteristics						
Drain-source breakdown voltage	V _{(BR)DSS}	V _{GS} = 0V, I _D =250μA	120	-	-	V
Zero gate voltage drain current	I _{DSS}	V _{DS} =96V, V _{GS} = 0V	-	-	1	μA
Gate-body leakage current	I _{GSS}	V _{GS} = ±20V, V _{DS} = 0V	-	-	±100	nA
Gate threshold voltage	V _{GS(th)}	V _{DS} =V _{GS} , I _D =250μA	2	-	4	V
Drain-source on-resistance ^(a)	R _{DS(on)}	V _{GS} =10V, I _D =50A		2.8	3.2	mΩ
		V _{GS} =6V, I _D =30A	-	3.4	3.9	mΩ
Dynamic characteristics^(b)						
Input Capacitance	C _{iss}	V _{DS} =60V, V _{GS} =0V, f =1.0MHz	-	9116	-	pF
Output Capacitance	C _{oss}		-	1041	-	
Reverse Transfer Capacitance	C _{rss}		-	69	-	
Switching characteristics^(b)						
Turn-on delay time	t _{d(on)}	V _{DD} =60V, I _D =50A, R _G =3.9Ω, V _G =10V, R _L =1.2Ω	-	26	-	nS
Turn-on rise time	t _r		-	87	-	
Turn-off delay time	t _{d(off)}		-	105	-	
Turn-off fall time	t _f		-	87	-	
Total Gate Charge	Q _g	V _{DS} =60V, I _D =50A, V _{GS} =10V	-	157	-	nC
Gate-Source Charge	Q _{gs}		-	47	-	
Gate-Drain Charge	Q _{gd}		-	37	-	
Source-Drain Diode characteristics						
Diode Forward voltage ^(a)	V _{SD}	T _J =25°C, V _{GS} =0V, I _S =50A	-	-	1.3	V
Diode Forward current	I _S	T _C =25°C	-	-	211	A
Body Diode Reverse Recovery Time	t _{rr}	T _J =25°C, I _F =50A, di/dt=100A/us		124		nS
Body Diode Reverse Recovery Charge	Q _{rr}	T _J =25°C, I _F =50A, di/dt=100A/us		368		nC

Notes:

- a) Pulse width ≤ 300 μs, duty cycle ≤ 2%
- b) Guaranteed by design, not subject to production testing

Test Circuit

Gate Charge Test Circuit & Waveform

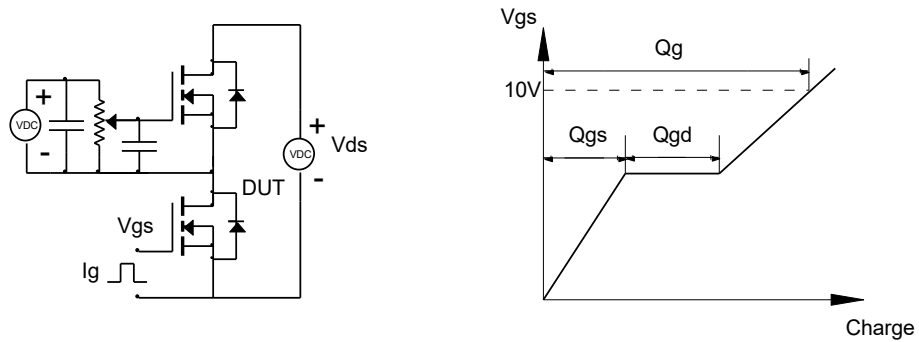

Resistive Switching Test Circuit & Waveforms

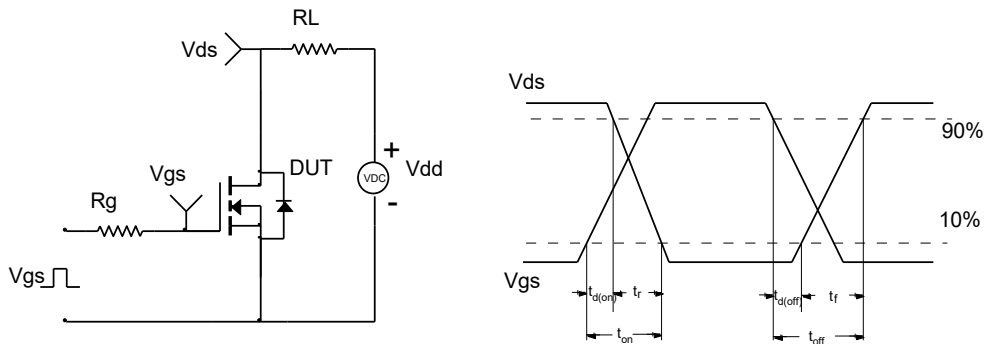

Unclamped Inductive Switching (UIS) Test Circuit & Waveforms

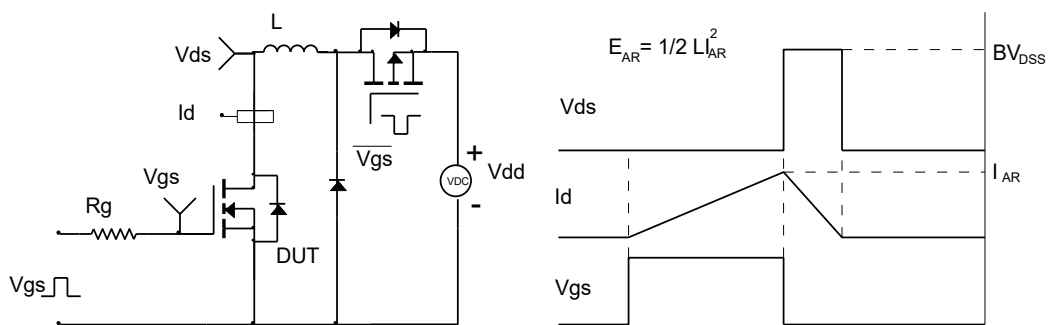

Diode Recovery Test Circuit & Waveforms

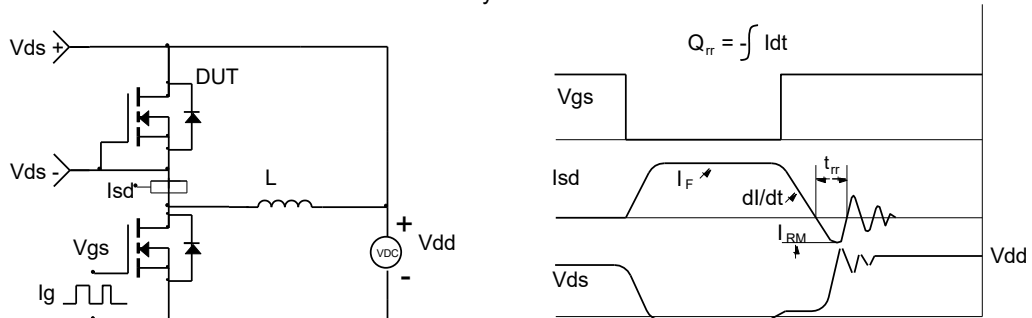

Typical Performance Characteristics

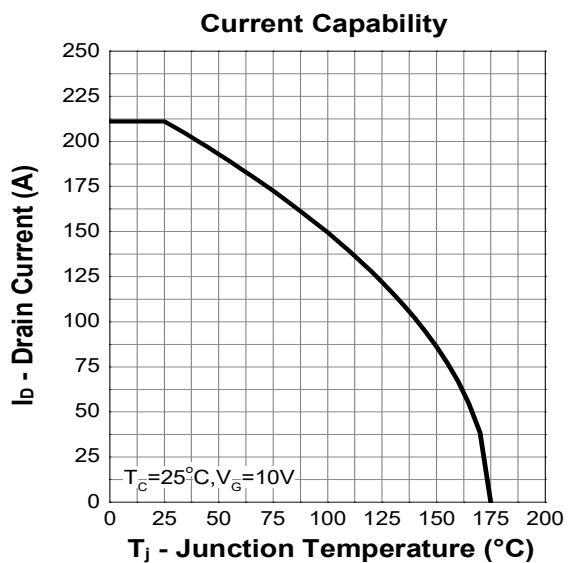
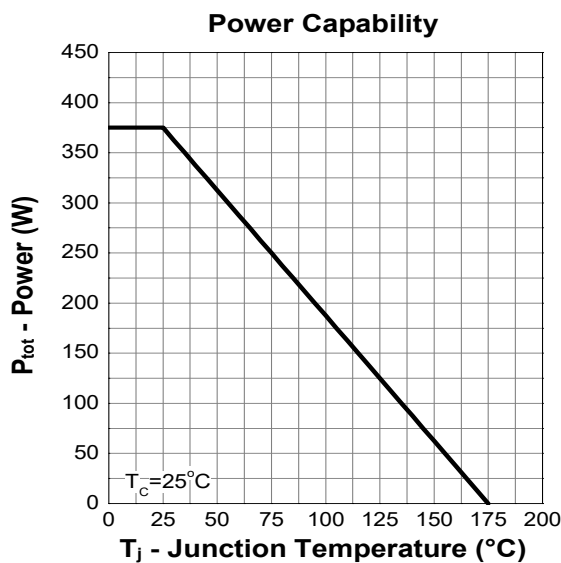
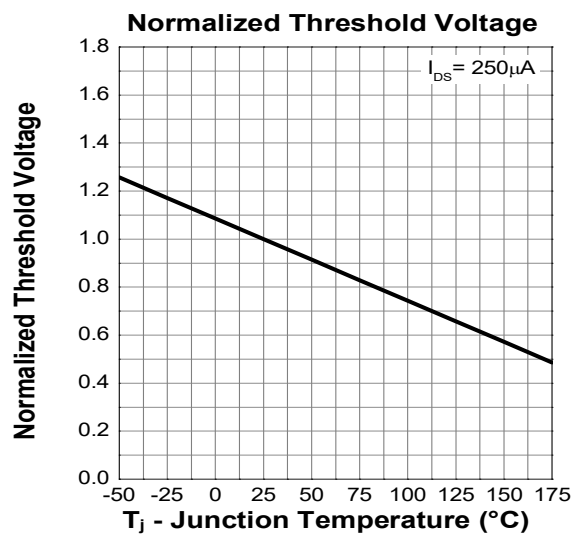
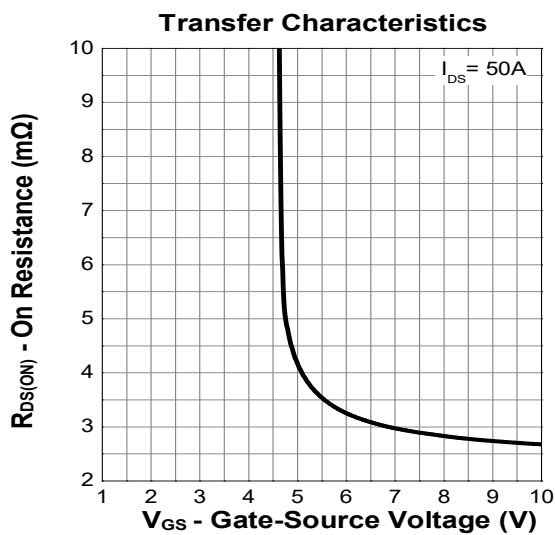
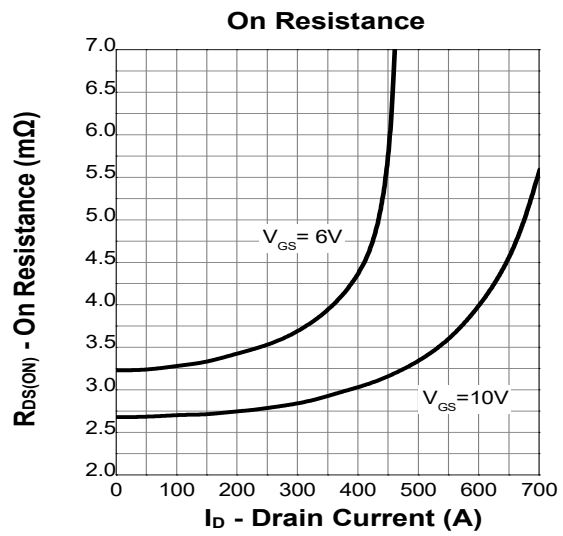
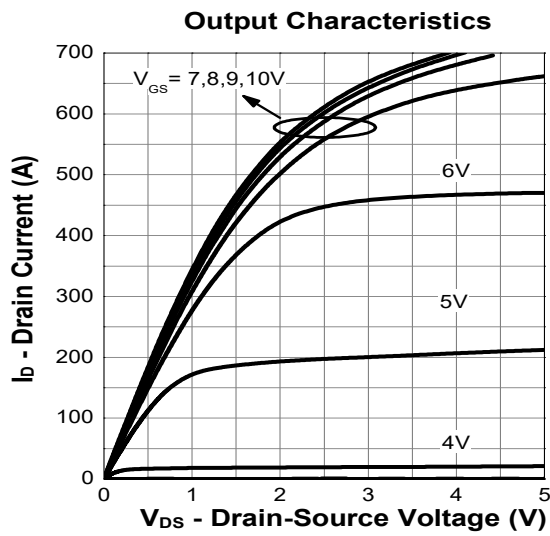

Typical Performance Characteristics

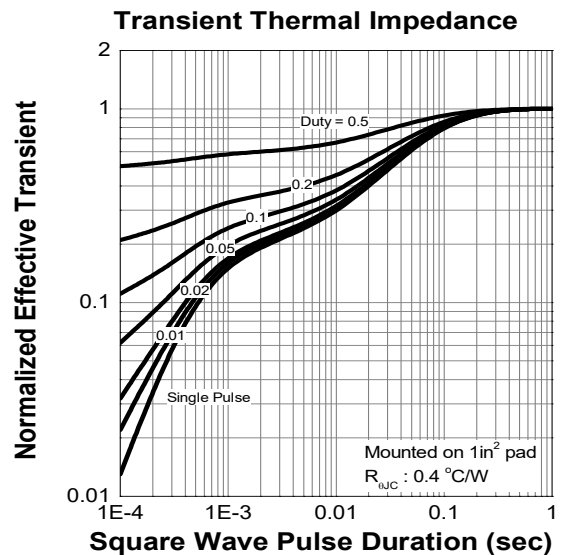
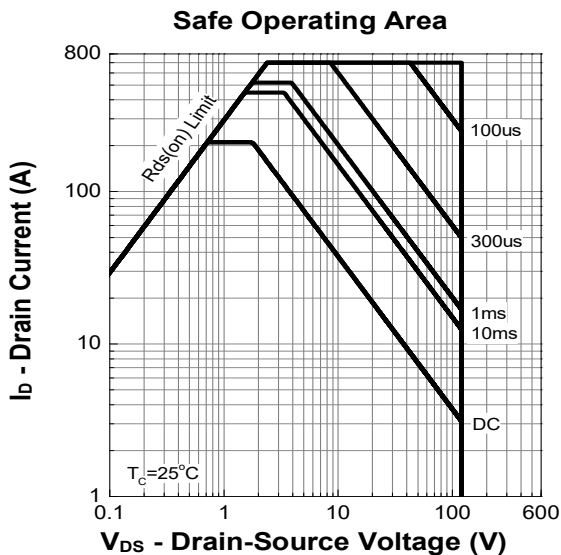
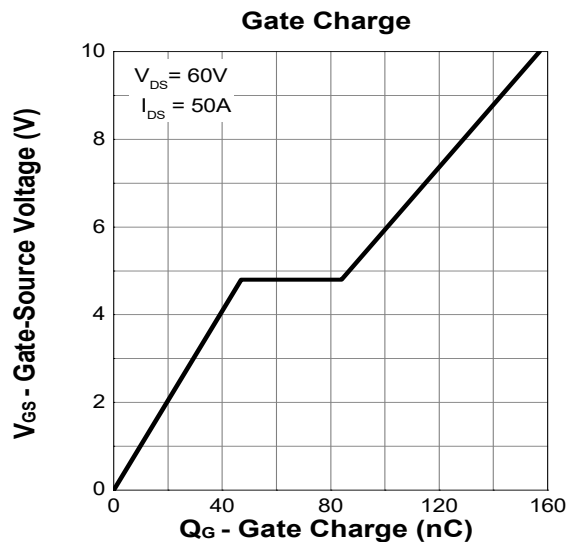
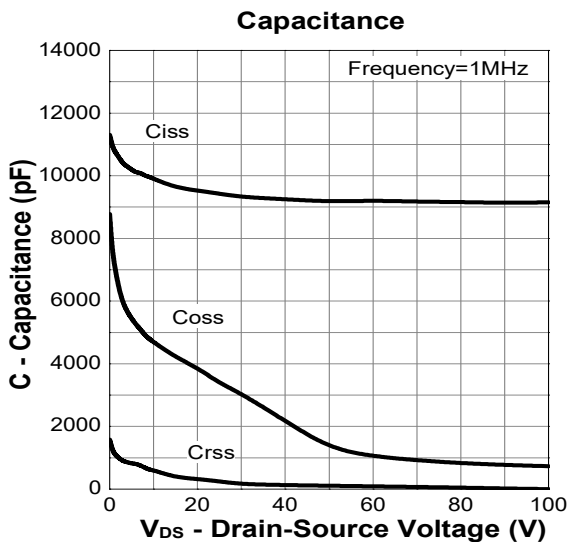
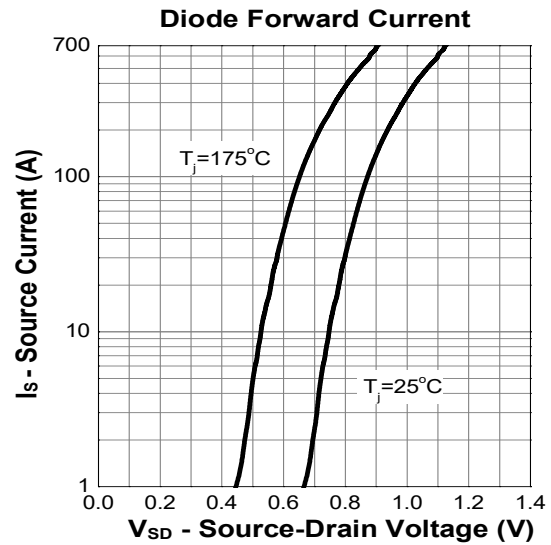
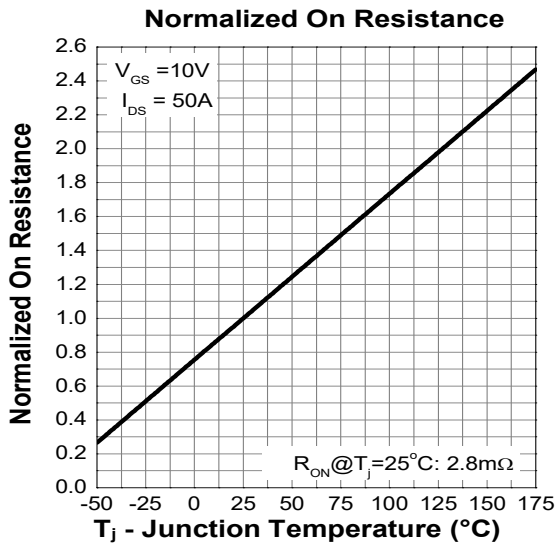

Package Dimensions

TOLL-8L Package

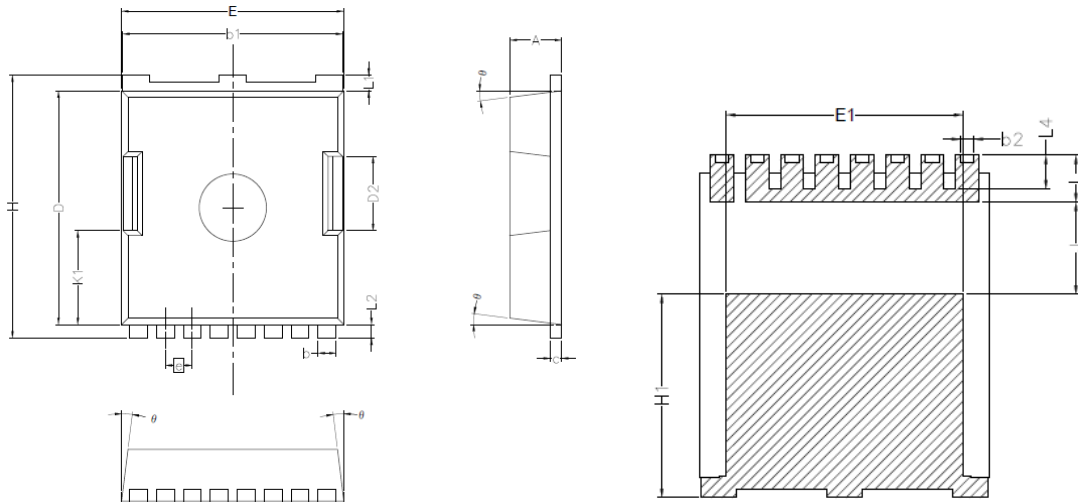

Symbol	Dimensions In Millimeters	
	MIN.	MAX.
A	2.20	2.40
b	0.90	0.90
b1	9.70	9.90
b2	0.42	0.50
c	0.40	0.60
D	10.28	10.58
D2	3.10	3.50
E	9.70	10.10
E1	7.90	8.30
e	1.20BSC	
H	11.48	11.88
H1	6.75	7.15
N	8	
J	3.00	3.30
K1	3.98	4.38
L	1.40	1.80
L1	0.60	0.80
L2	0.50	0.70
L4	1.00	1.30
θ	4°	10°

Revision History

Revision	Release	Remark
V1.0	2023/03/07	Initial Release

Disclaimer

The information given in this document describes the independent performance of the product, but similar performance is not guaranteed under other working conditions, and cannot be guaranteed when installed with other products or equipment. To achieve the required performance of the product in actual scenarios, the customer should conduct a complete application test to assess the functionality of the product.

Allpower assumes no responsibility for equipment failures result from using products at values that exceed the ratings, operating conditions, or other parameters listed in the product specifications.

The product described in this specification is not applicable for aerospace or other applications which requires high reliability. Customers using or selling these products for use in medical, life-saving, or life-sustaining applications do so at their own risk and agree to fully indemnify.

Due to product or technical improvements, the information described or contained herein may be changed without prior notice.

