

# AP3908QD

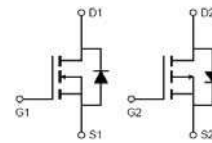
N and P-Channel Enhancement Mosfet

# AIPOWER

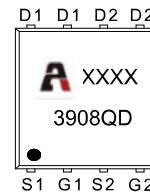
## DATA SHEET

### Feature

- **N-Channel**  
30V,20A  
 $R_{DS(ON)} < 14m\Omega @ V_{GS}=10V$  TYP: 10.5m $\Omega$   
 $R_{DS(ON)} < 22m\Omega @ V_{GS}=4.5V$  TYP: 17m $\Omega$
- **P-Channel**  
-30V,-20A  
 $R_{DS(ON)} < 23m\Omega @ V_{GS}=-10V$  TYP: 17.5m $\Omega$   
 $R_{DS(ON)} < 32m\Omega @ V_{GS}=-4.5V$  TYP: 24m $\Omega$
- Lead free product is acquired
- High power and current handing capability
- Surface mount package



Schematic diagram



Marking and pin assignment

### Application

- PWM applications
- Load Switch
- Power management

### Package Marking and Ordering Information

Device Marking	Device	Device Package	Reel Size	Tape width	Quantity (PCS)
3908QD	AP3908QD	PDFN3X3-D	-	-	5000

### ABSOLUTE MAXIMUM RATINGS ( $T_J=25^\circ\text{C}$ unless otherwise noted)

Parameter	Symbol	N-Channel	P-Channel	Unit
Drain-Source Voltage	$V_{DS}$	30	-30	V
Gate-Source Voltage	$V_{GS}$	$\pm 20$	$\pm 20$	V
Continuous Drain Current ( $T_c=25^\circ\text{C}$ )	$I_D$	20	-20	A
Continuous Drain Current ( $T_c=100^\circ\text{C}$ )	$I_D$	14.1	-14	A
Pulsed Drain Current <sup>(1)</sup>	$I_{DM}$	80	-60	A
Power Dissipation	$P_D$	21		W
Thermal Resistance from Junction to Ambient <sup>(2)</sup>	$R_{\theta JA}$	6.25		$^\circ\text{C}/\text{W}$
Junction Temperature	$T_J$	150		$^\circ\text{C}$
Storage Temperature	$T_{STG}$	-55~ +150		$^\circ\text{C}$

#### Notes:

- 1) Repetitive Rating: pulse width limited by maximum junction temperature
- 2) The value of  $R_{\theta JA}$  Mounted on FR4 Board (25.4mm\*25.4mm\*t1.6mm) With 2oz Copper,  $T_a=25^\circ\text{C}$

# AP3908QD

N and P-Channel Enhancement Mosfet

# AIIPOWER

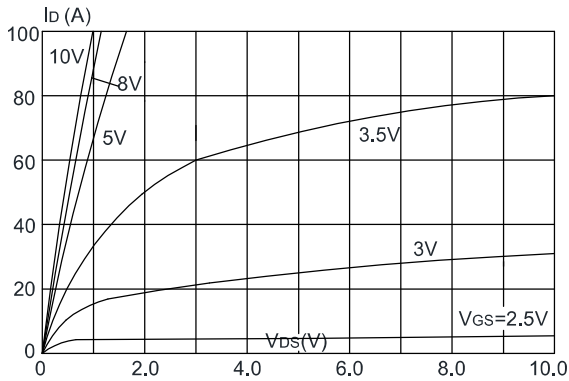
## DATA SHEET

### N-CH ELECTRICAL CHARACTERISTICS( $T_J=25^{\circ}\text{C}$ unless otherwise noted)

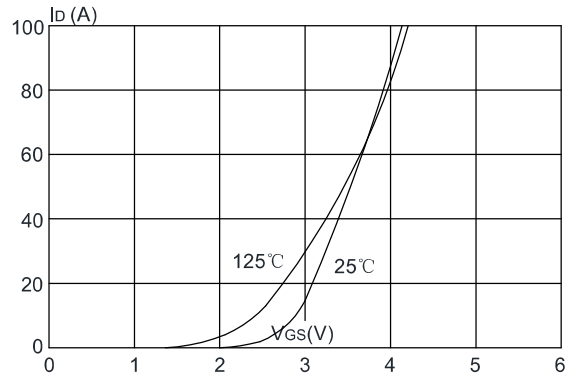
Parameter	Symbol	Test Condition	Min	Type	Max	Unit
<b>Static Characteristics</b>						
Drain-source breakdown voltage	$V_{(BR)DSS}$	$V_{GS} = 0V, I_D = 250\mu A$	30			V
Zero gate voltage drain current	$I_{DSS}$	$V_{DS} = 30V, V_{GS} = 0V$			1	$\mu A$
Gate-body leakage current	$I_{GSS}$	$V_{GS} = \pm 20V, V_{DS} = 0V$			$\pm 100$	nA
Gate threshold voltage	$V_{GS(th)}$	$V_{DS} = V_{GS}, I_D = 250\mu A$	1	1.5	2.5	V
Drain-source on-resistance	$R_{DS(on)}$	$V_{GS} = 10V, I_D = 10A$		10.5	14	m $\Omega$
		$V_{GS} = 4.5V, I_D = 5A$		17	22	
Forward transconductance	$g_{FS}$	$V_{DS} = 10V, I_D = 10A$		10		S
<b>Dynamic characteristics</b>						
Input Capacitance	$C_{iss}$	$V_{DS} = 15V, V_{GS} = 0V, f = 1MHz$		900		pF
Output Capacitance	$C_{oss}$			140		
Reverse Transfer Capacitance	$C_{rss}$			120		
<b>Switching characteristics</b>						
Turn-on delay time	$t_{d(on)}$	$V_{DD} = 15V, I_D = 10A$ $V_{GS} = 10V, R_G = 3\Omega$		6		ns
Turn-on rise time	$t_r$			5		
Turn-off delay time	$t_{d(off)}$			25		
Turn-off fall time	$t_f$			7		
Total Gate Charge	$Q_g$	$V_{DS} = 15V, I_D = 20A,$ $V_{GS} = 10V$		19		nC
Gate-Source Charge	$Q_{gs}$			6.3		
Gate-Drain Charge	$Q_{gd}$			4.5		
<b>Source-Drain Diode characteristics</b>						
Diode Forward voltage	$V_{DS}$	$V_{GS} = 0V, I_S = 10A$			1.2	V
Diode Forward current	$I_S$		-	-	20	A

**Typical Performance Characteristics**

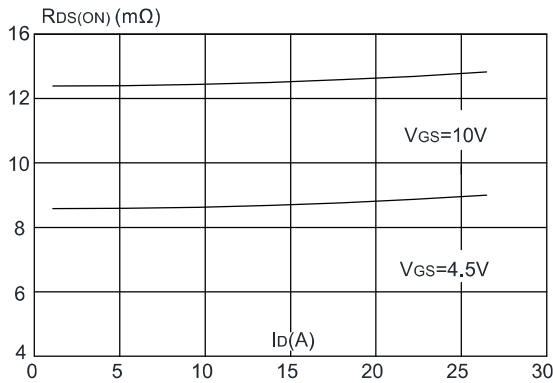
**Figure 1: Output Characteristics**



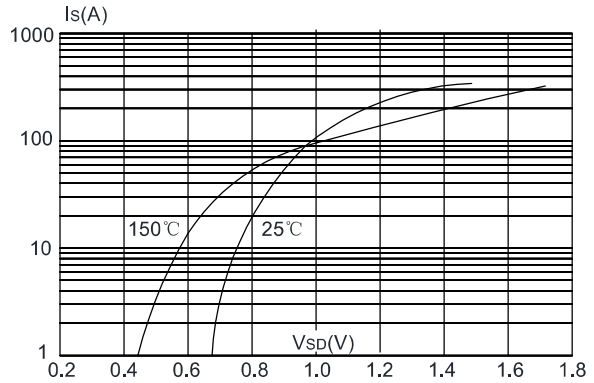
**Figure 2: Typical Transfer Characteristics**



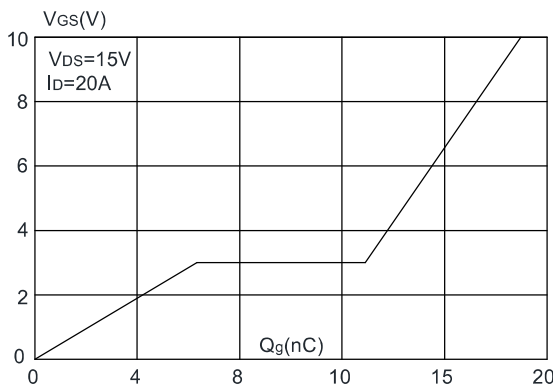
**Figure 3: On-resistance vs. Drain Current**



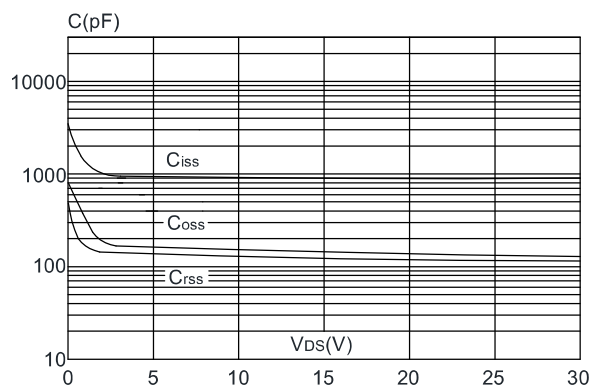
**Figure 4: Body Diode Characteristics**



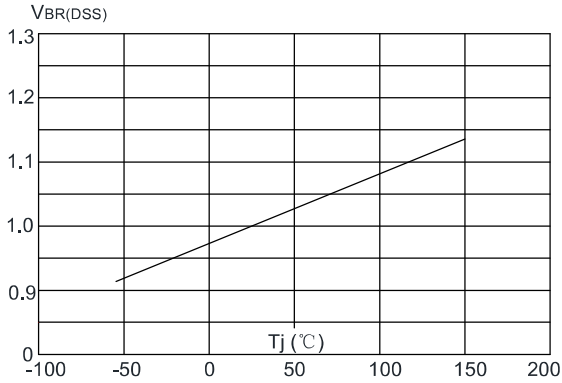
**Figure 5: Gate Charge Characteristics**



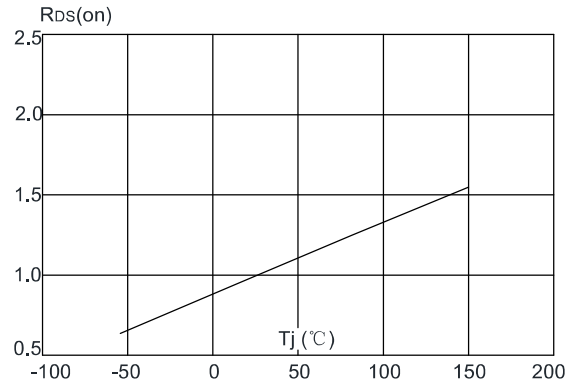
**Figure 6: Capacitance Characteristics**



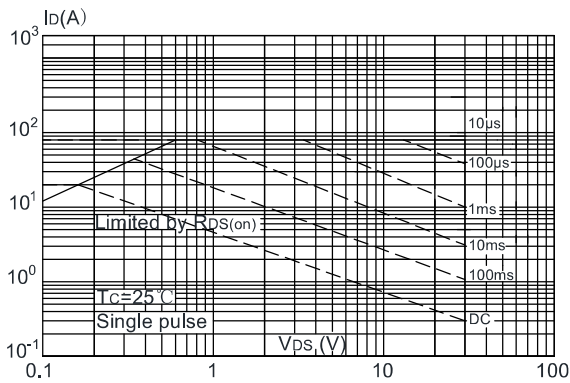
**Figure 7: Normalized Breakdown Voltage vs. Junction Temperature**



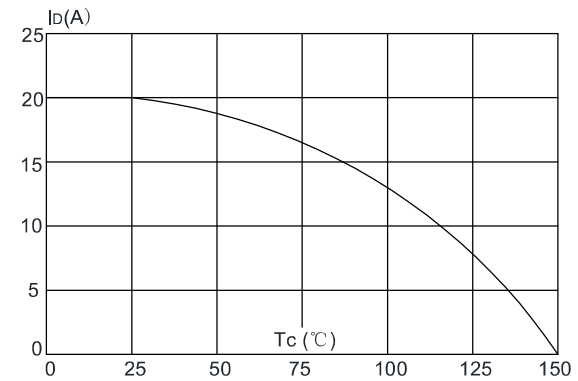
**Figure 8: Normalized on Resistance vs. Junction Temperature**



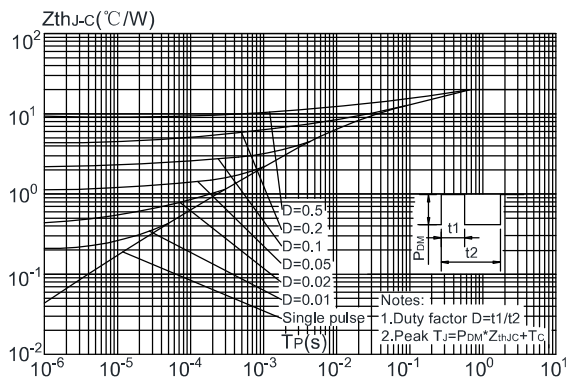
**Figure 9: Maximum Safe Operating Area**



**Figure 10: Maximum Continuous Drain Current vs. Case Temperature**



**Figure.11: Maximum Effective Transient Thermal Impedance, Junction-to-Case**



**Test Circuit**

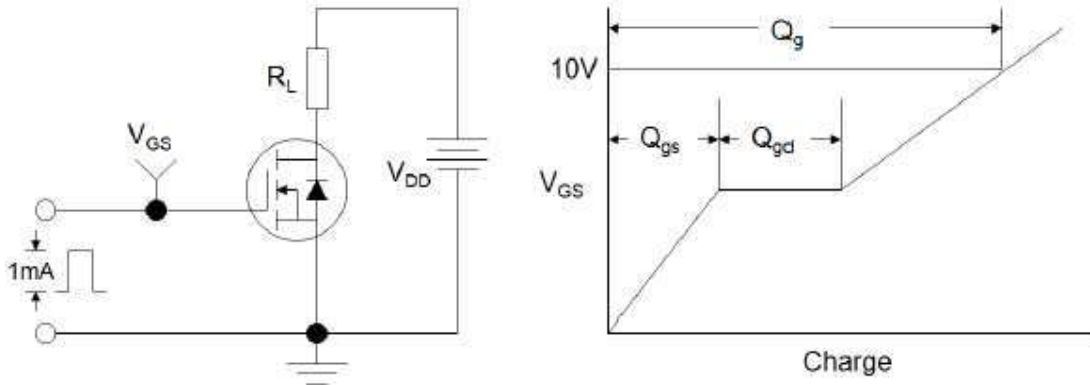


Figure1:Gate Charge Test Circuit & Waveform

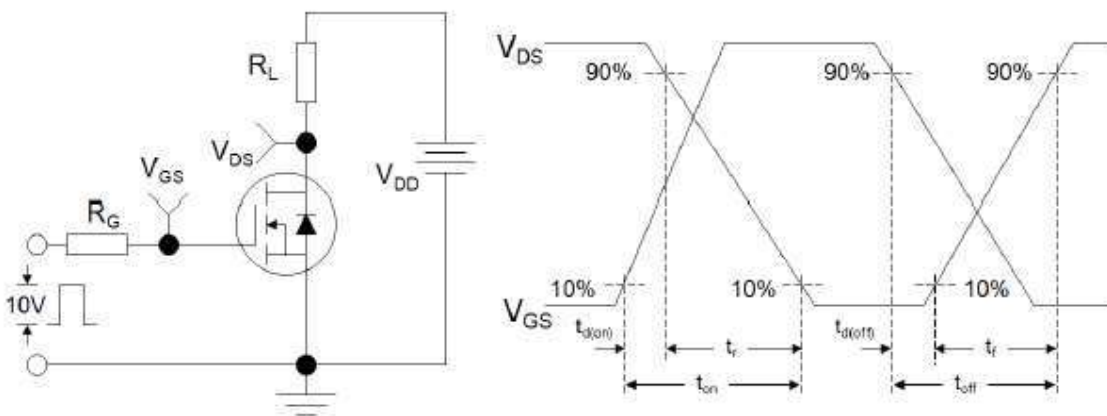


Figure 2: Resistive Switching Test Circuit & Waveforms

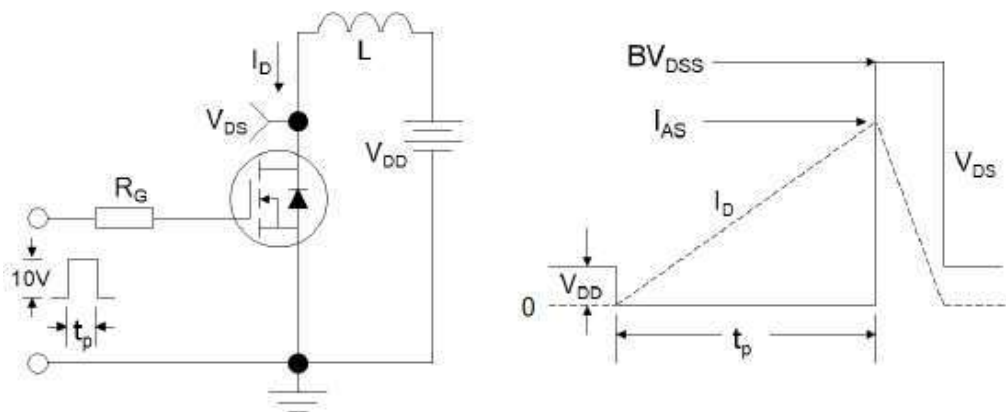


Figure 3:Unclamped Inductive Switching Test Circuit & Waveforms

# AP3908QD

N and P-Channel Enhancement Mosfet

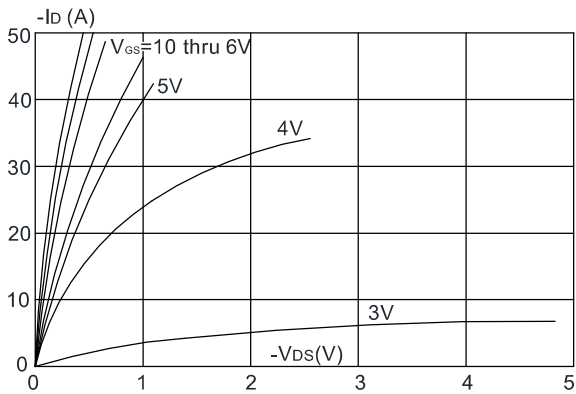
# AIIPOWER

DATA SHEET

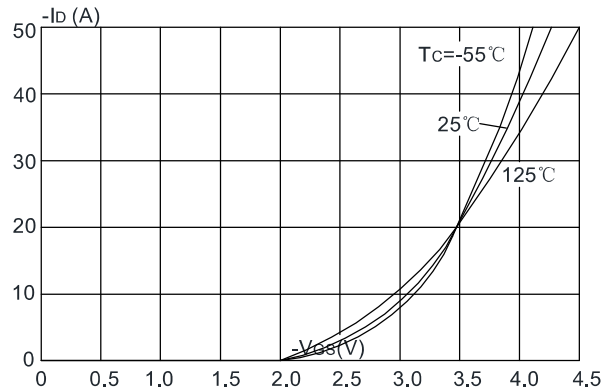
## P-CH ELECTRICAL CHARACTERISTICS(T<sub>J</sub>=25°C unless otherwise noted)

Parameter	Symbol	Test Condition	Min	Type	Max	Unit
<b>Static Characteristics</b>						
Drain-source breakdown voltage	V <sub>(BR)DSS</sub>	V <sub>GS</sub> = 0V, I <sub>D</sub> = -250μA	-30			V
Zero gate voltage drain current	I <sub>DSS</sub>	V <sub>DS</sub> = -30V, V <sub>GS</sub> = 0V			1	μA
Gate-body leakage current	I <sub>GSS</sub>	V <sub>GS</sub> = ±20V, V <sub>DS</sub> = 0V			±100	nA
Gate threshold voltage	V <sub>GS(th)</sub>	V <sub>DS</sub> = V <sub>GS</sub> , I <sub>D</sub> = -250μA	-1	-1.5	-2.5	V
Drain-source on-resistance	R <sub>DS(on)</sub>	V <sub>GS</sub> = -10V, I <sub>D</sub> = -10A		17.5	23	mΩ
		V <sub>GS</sub> = -4.5V, I <sub>D</sub> = -5A		24	32	
Forward transconductance	g <sub>FS</sub>	V <sub>DS</sub> = -10V, I <sub>D</sub> = -10A		20		S
<b>Dynamic characteristics</b>						
Input Capacitance	C <sub>iss</sub>	V <sub>DS</sub> = -15V, V <sub>GS</sub> = 0V, f = 1MHz		1550		pF
Output Capacitance	C <sub>oss</sub>			327		
Reverse Transfer Capacitance	C <sub>rss</sub>			278		
<b>Switching characteristics</b>						
Turn-on delay time	t <sub>d(on)</sub>	V <sub>DD</sub> = -15V, I <sub>D</sub> = -6A V <sub>GS</sub> = -10V, R <sub>G</sub> = 2.5Ω		14		ns
Turn-on rise time	t <sub>r</sub>			20		
Turn-off delay time	t <sub>d(off)</sub>			95		
Turn-off fall time	t <sub>f</sub>			65		
Total Gate Charge	Q <sub>g</sub>	V <sub>DS</sub> = -15V, I <sub>D</sub> = -10A, V <sub>GS</sub> = -10V		30		nC
Gate-Source Charge	Q <sub>gs</sub>			5.3		
Gate-Drain Charge	Q <sub>gd</sub>			7.6		
<b>Source-Drain Diode characteristics</b>						
Diode Forward voltage	V <sub>DS</sub>	V <sub>GS</sub> = 0V, I <sub>S</sub> = -10A			1.2	V
Diode Forward current	I <sub>S</sub>		-	-	-20	A

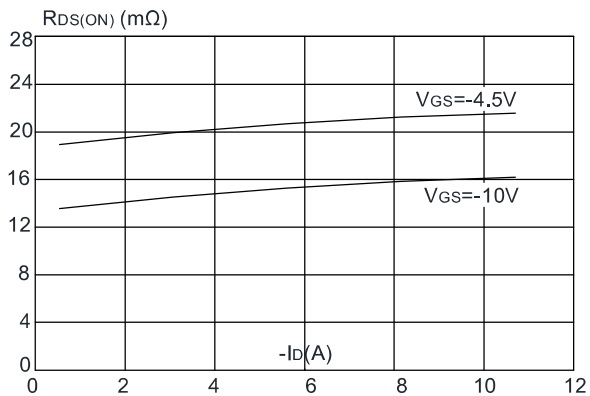
**Figure 1: Output Characteristics**



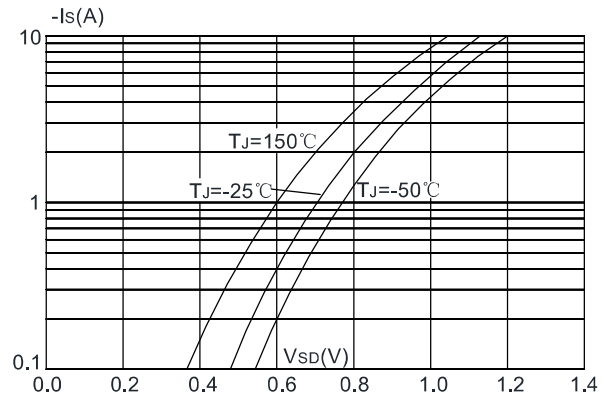
**Figure 2: Typical Transfer Characteristics**



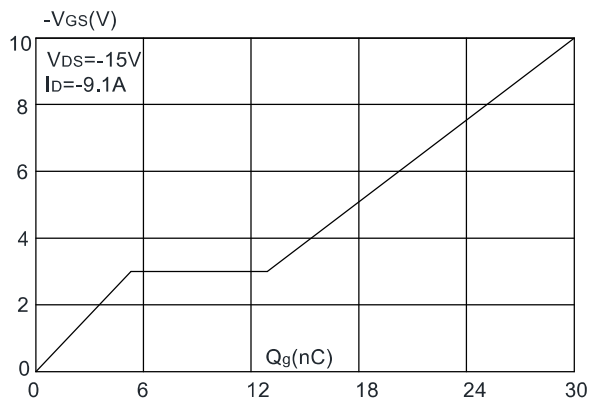
**Figure 3: On-resistance vs. Drain Current**



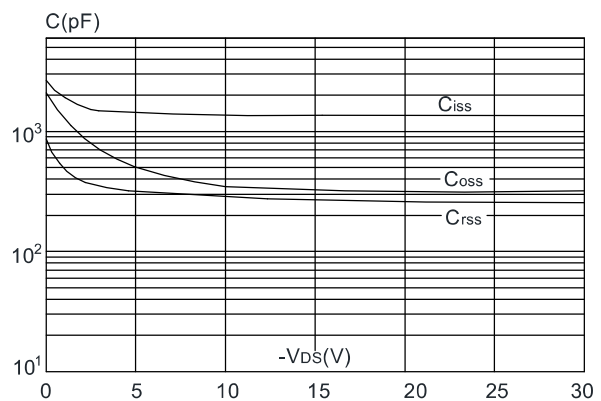
**Figure 4: Body Diode Characteristics**



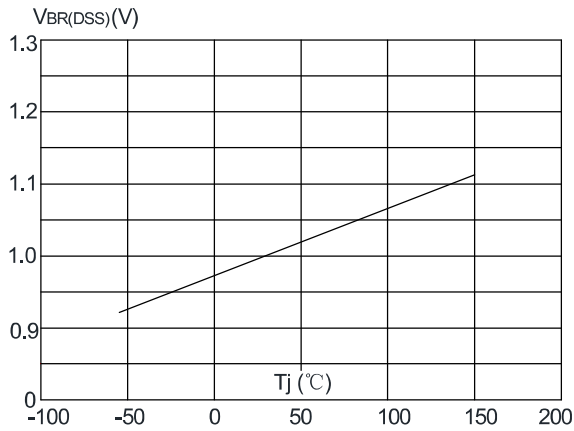
**Figure 5: Gate Charge Characteristics**



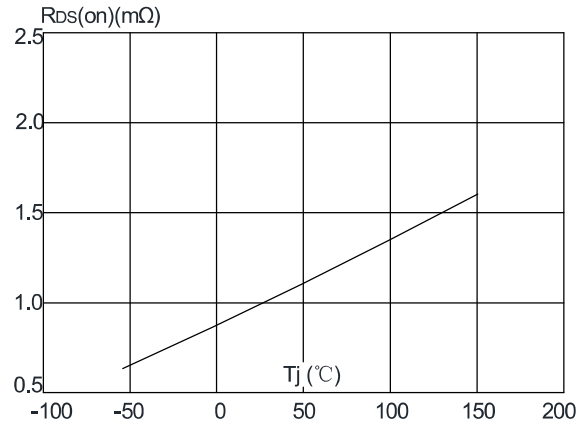
**Figure 6: Capacitance Characteristics**



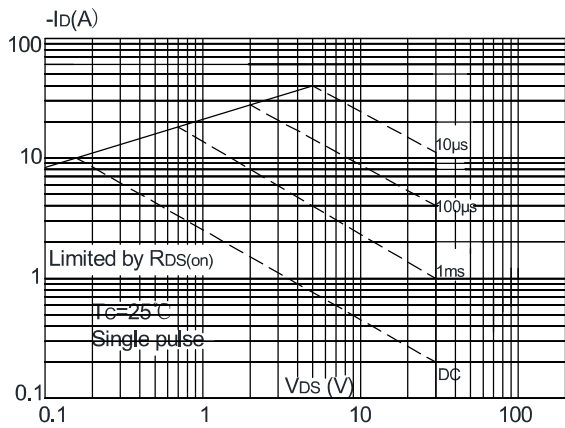
**Figure 7:** Normalized Breakdown Voltage vs. Junction Temperature



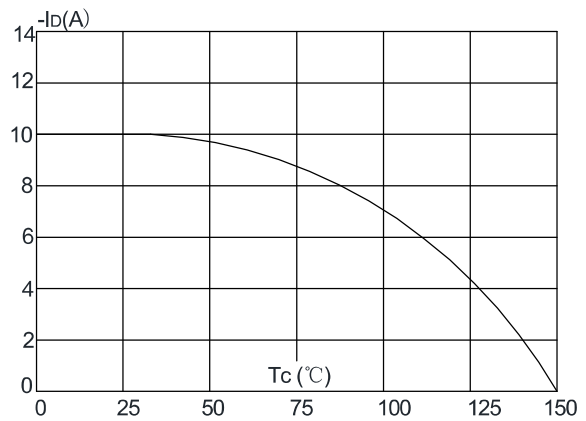
**Figure 8:** Normalized on Resistance vs. Junction Temperature



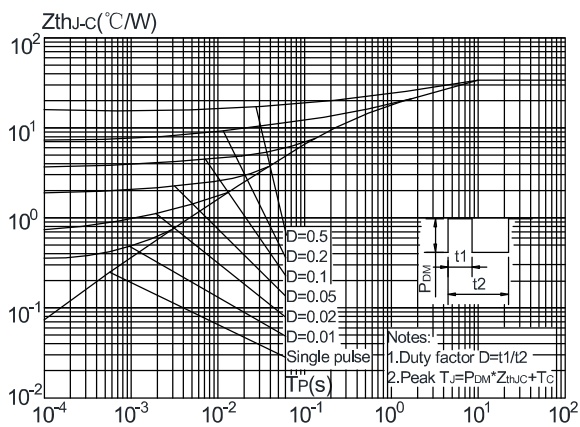
**Figure 9:** Maximum Safe Operating Area



**Figure 10:** Maximum Continuous Drain Current vs. Case Temperature

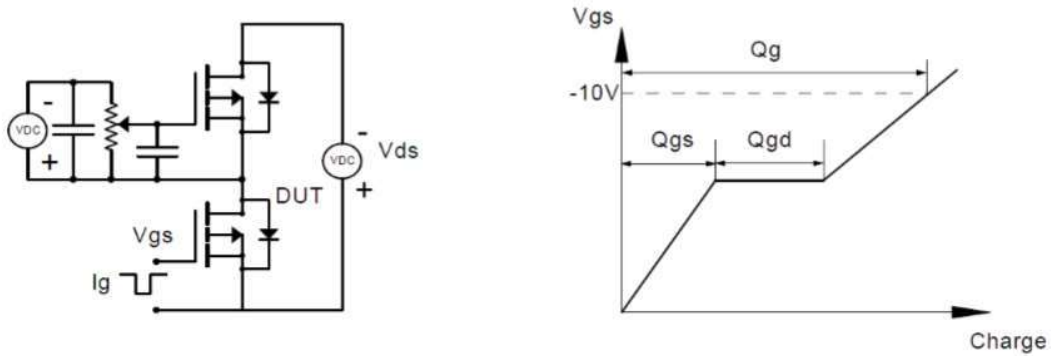


**Figure.11:** Maximum Effective Transient Thermal Impedance, Junction-to-Ambient

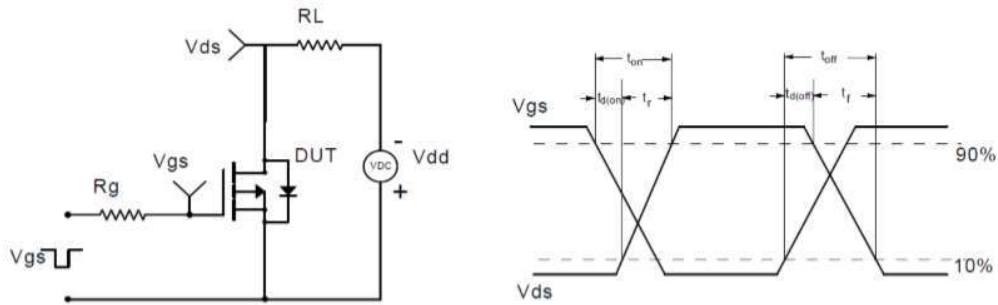




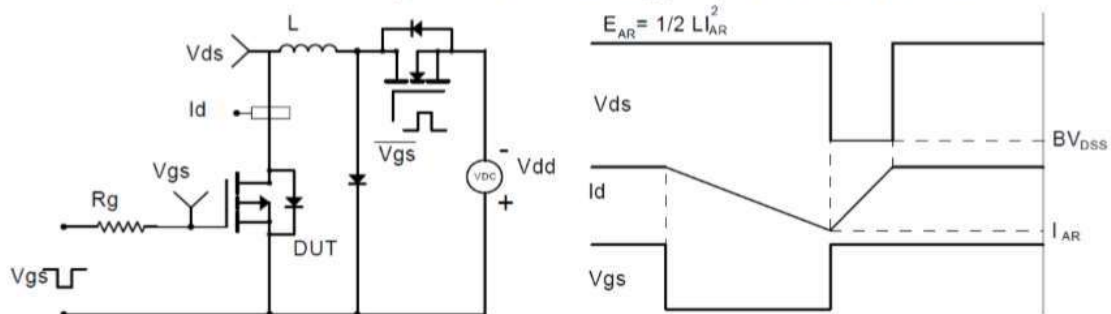
Gate Charge Test Circuit & Waveform



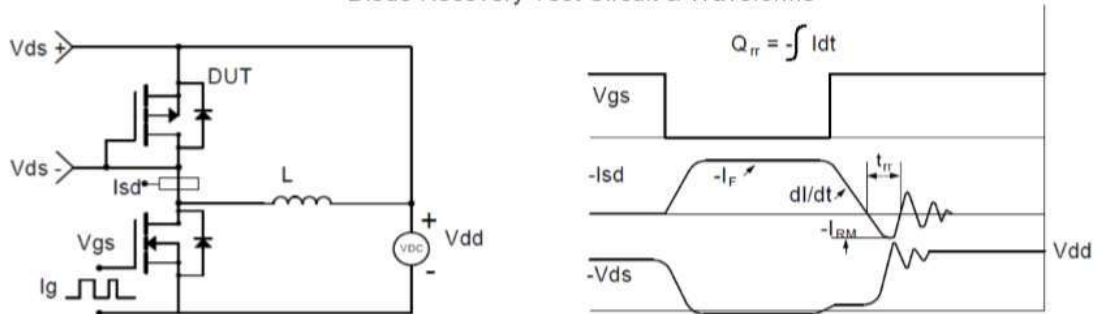
Resistive Switching Test Circuit & Waveforms



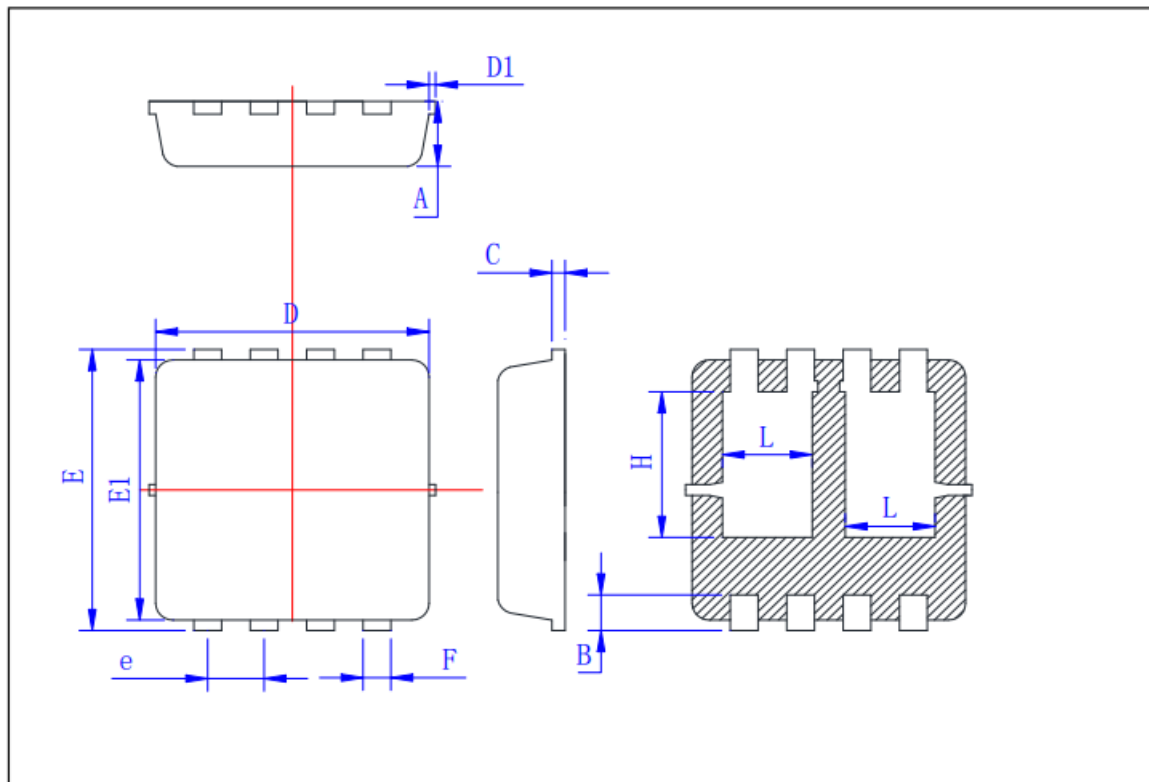
Unclamped Inductive Switching (UIS) Test Circuit & Waveforms



Diode Recovery Test Circuit & Waveforms



**PDFN3X3-D Package Information**



Symbol	Min	Typ	Max
A	0.725	0.775	0.825
B	0.28	0.38	0.48
C	0.13	0.15	0.20
D	3.05	3.15	3.25
D1			0.10
E	3.25	3.35	3.45
E1	3.0	3.1	3.2
e	0.60	0.65	0.70
F	0.27	0.32	0.37
H	1.63	1.73	1.83
L	0.93	1.03	1.13

## Revision History

Revision	Release	Remark
V1.0	2024/05/10	Reset

## Disclaimer

The information given in this document describes the independent performance of the product, but similar performance is not guaranteed under other working conditions, and cannot be guaranteed when installed with other products or equipment. To achieve the required performance of the product in actual scenarios, the customer should conduct a complete application test to assess the functionality of the product.

Allpower assumes no responsibility for equipment failures result from using products at values that exceed the ratings, operating conditions, or other parameters listed in the product specifications.

The product described in this specification is not applicable for aerospace or other applications which requires high reliability. Customers using or selling these products for use in medical, life-saving, or life-sustaining applications do so at their own risk and agree to fully indemnify.

Due to product or technical improvements, the information described or contained herein may be changed without prior notice.